

## CD4007M/CD4007C Dual Complementary Pair Plus Inverter

### General Description

The CD4007M/CD4007C consists of three complementary pairs of N- and P-channel enhancement mode MOS transistors suitable for series/shunt applications. All inputs are protected from static discharge by diode clamps to  $V_{DD}$  and  $V_{SS}$ .

For proper operation the voltages at all pins must be constrained to be between  $V_{SS} - 0.3V$  and  $V_{DD} + 0.3V$  at all times.

### Features

- Wide supply voltage range
- High noise immunity

3.0V to 15V  
0.45  $V_{CC}$  (typ.)

### Connection Diagram

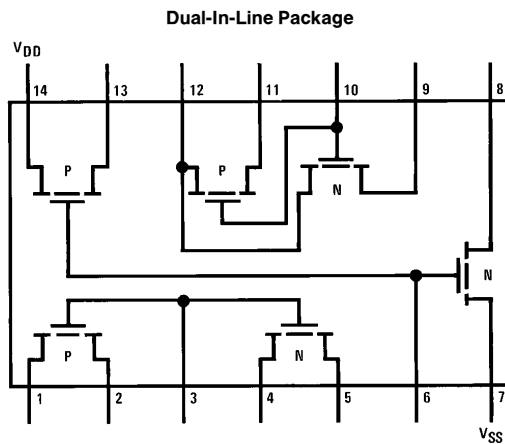

TL/F/5943-1

**Top View**

**Note:** All P-channel substrates are connected to  $V_{DD}$   
and all N-channel substrates are connected to  $V_{SS}$ .

**Order Number CD4007**

### Absolute Maximum Ratings (Note 1)

If Military/Aerospace specified devices are required, please contact the National Semiconductor Sales Office/Distributors for availability and specifications.

Voltage at Any Pin  $V_{SS} - 0.3V$  to  $V_{DD} + 0.3V$

Operating Temperature Range  
 CD4007M  $-55^{\circ}C$  to  $+125^{\circ}C$   
 CD4007C  $-40^{\circ}C$  to  $+85^{\circ}C$

Storage Temperature Range  $-65^{\circ}C$  to  $+150^{\circ}C$

Power Dissipation ( $P_D$ )  
 Dual-In-Line 700 mW  
 Small Outline 500 mW

Operating  $V_{DD}$  Range  $V_{SS} + 3.0V$  to  $V_{SS} + 15V$

Lead Temperature (Soldering, 10 seconds) 260°C

### DC Electrical Characteristics CD4007M

Symbol	Parameter	Conditions	Limits									Units
			$-55^{\circ}C$			$+25^{\circ}C$			$+125^{\circ}C$			
			Min	Typ	Max	Min	Typ	Max	Min	Typ	Max	
$I_L$	Quiescent Device Current	$V_{DD} = 5.0V$ $V_{DD} = 10V$			0.05		0.001	0.05			3.0	$\mu A$
					0.1		0.001	0.1			6.0	$\mu A$
$P_D$	Quiescent Device Dissipation Package	$V_{DD} = 5.0V$ $V_{DD} = 10V$			0.25		0.005	0.25			15	$\mu W$
					1.0		0.001	1.0			60	$\mu W$
$V_{OL}$	Output Voltage Low Level	$V_{DD} = 5.0V$ $V_{DD} = 10V$			0.05		0	0.05			0.05	V
					0.05		0	0.05			0.05	V
$V_{OH}$	Output Voltage High Level	$V_{DD} = 5.0V$ $V_{DD} = 10V$	4.95		4.95	5.0		4.95				V
			9.95		9.95	10		9.95				V
$V_{NL}$	Noise Immunity (All Inputs)	$V_{DD} = 5.0V, V_O = 3.6V$ $V_{DD} = 10V, V_O = 7.2V$			1.5		2.25	1.5			1.4	V
					3.0		4.5	3.0			2.9	V
$V_{NH}$	Noise Immunity (All Inputs)	$V_{DD} = 5.0V, V_O = 0.95V$ $V_{DD} = 10V, V_O = 2.9V$	3.6		3.5	2.25		3.5				V
			7.1		7.0	4.5		7.0				V
$I_{DN}$	Output Drive Current N-Channel	$V_{DD} = 5.0V, V_O = 0.4V, V_I = V_{DD}$ $V_{DD} = 10V, V_O = 0.5V, V_I = V_{DD}$	0.75		0.6	1.0		0.4				mA
			1.6		1.3	2.5		0.95				mA
$I_{DP}$	Output Drive Current P-Channel	$V_{DD} = 5.0V, V_O = 2.5V, V_I = V_{SS}$ $V_{DD} = 10V, V_O = 9.5V, V_I = V_{SS}$	-1.75		-1.4	-4.0		-1.0				mA
			-1.35		-1.1	-2.5		-0.75				mA
$I_I$	Input Current					10					pA	

### DC Electrical Characteristics CD4007C

Symbol	Parameter	Conditions	Limits									Units
			$-40^{\circ}C$			$+25^{\circ}C$			$+85^{\circ}C$			
			Min	Typ	Max	Min	Typ	Max	Min	Typ	Max	
$I_L$	Quiescent Device Current	$V_{DD} = 5.0V$ $V_{DD} = 10V$			0.5		0.005	0.05			15	$\mu A$
					1.0		0.005	1.0			30	$\mu A$
$P_D$	Quiescent Device Dissipation Package	$V_{DD} = 5.0V$ $V_{DD} = 10V$			2.5		0.025	2.5			75	$\mu W$
					10		0.05	10			300	$\mu W$
$V_{OL}$	Output Voltage Low Level	$V_{DD} = 5.0V$ $V_{DD} = 10V$			0.05		0	0.01			0.05	V
					0.05		0	0.01			0.05	V
$V_{OH}$	Output Voltage High Level	$V_{DD} = 5.0V$ $V_{DD} = 10V$	4.95		4.95	5.0		4.95				V
			9.95		9.95	10		9.95				V
$V_{NL}$	Noise Immunity (All inputs)	$V_{DD} = 5.0V, V_O = 3.6V$ $V_{DD} = 10V, V_O = 7.2V$			1.5		2.25	1.5			1.4	V
					3.0		4.5	3.0			2.9	V
$V_{NH}$	Noise Immunity (All Inputs)	$V_{DD} = 5.0V, V_O = 0.95V$ $V_{DD} = 10V, V_O = 2.9V$	3.6		3.5	2.25		3.5				V
			7.1		7.0	4.5		7.0				V
$I_{DN}$	Output Drive Current N-Channel	$V_{DD} = 5.0V, V_O = 0.4V, V_I = V_{DD}$ $V_{DD} = 10V, V_O = 0.5V, V_I = V_{DD}$	0.35		0.3	1.0		0.24				mA
			1.2		1.0	2.5		0.8				mA
$I_{DP}$	Output Drive Current P-Channel	$V_{DD} = 5.0V, V_O = 2.5V, V_I = V_{SS}$ $V_{DD} = 10V, V_O = 9.5V, V_I = V_{SS}$	-1.3		-1.1	-4.0		-0.9				mA
			-0.65		-0.55	-2.5		-0.45				mA
$I_I$	Input Current					10					pA	

Note 1: This device should not be connected to circuits with the power on because high transient voltages may cause permanent damage.

### AC Electrical Characteristics\* CD4007M

$T_A = 25^\circ\text{C}$  and  $C_L = 15\text{ pF}$  and rise and fall times = 20 ns. Typical temperature coefficient for all values of  $V_{DD} = 0.3\%/^\circ\text{C}$

Symbol	Parameter	Conditions	Min	Typ	Max	Units
$t_{PLH} = t_{PHL}$	Propagation Delay Time	$V_{DD} = 5.0\text{V}$		35	60	ns
		$V_{DD} = 10\text{V}$		20	40	ns
$t_{TLH} = t_{THL}$	Transition Time	$V_{DD} = 5.0\text{V}$		50	75	ns
		$V_{DD} = 10\text{V}$		30	40	ns
$C_I$	Input Capacitance	Any Input		5.0		pF

\*AC Parameters may be generated by DC correlated testing.

### AC Electrical Characteristics\* CD4007C

$T_A = 25^\circ\text{C}$  and  $C_L = 15\text{ pF}$  and rise and fall times = 20 ns. Typical temperature coefficient for all values of  $V_{DD} = 0.3\%/^\circ\text{C}$

Symbol	Parameter	Conditions	Min	Typ	Max	Units
$t_{PLH} = t_{PHL}$	Propagation Delay Time	$V_{DD} = 5.0\text{V}$		35	75	ns
		$V_{DD} = 10\text{V}$		20	50	ns
$t_{TLH} = t_{THL}$	Transition Time	$V_{DD} = 5.0\text{V}$		50	100	ns
		$V_{DD} = 10\text{V}$		30	50	ns
$C_I$	Input Capacitance	Any Input		5		pF

\*AC Parameters are guaranteed by DC correlated testing.

### AC Test Circuits

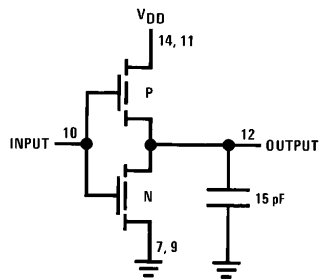

TL/F/5943-2

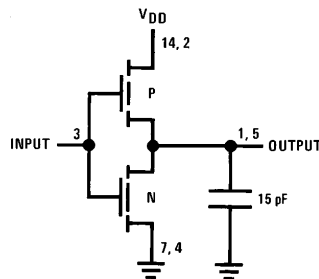

TL/F/5943-3

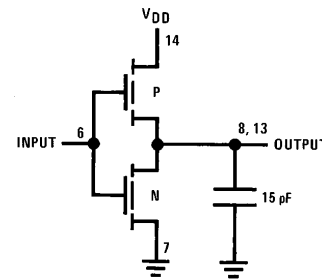

TL/F/5943-4

### Switching Time Waveforms

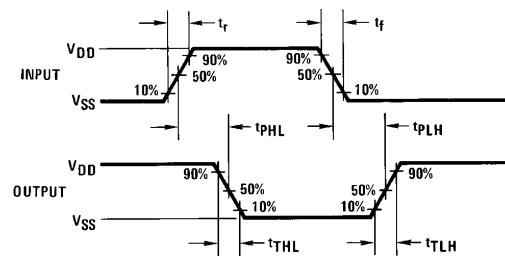

TL/F/5943-5

**Physical Dimensions** inches (millimeters)

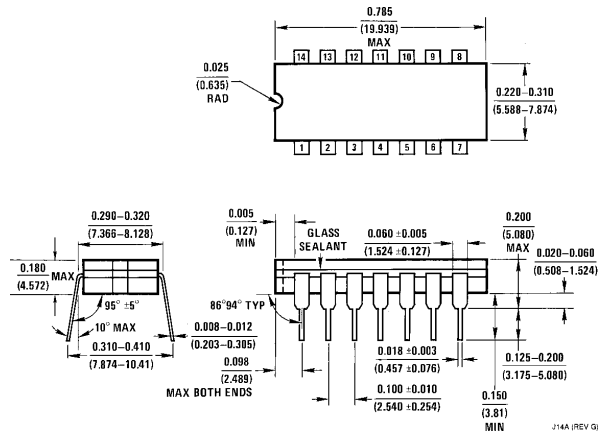

**Ceramic Dual-In-Line Package (J)**  
**Order Number CD4007MJ or CD4007CJ**  
**NS Package Number J14A**

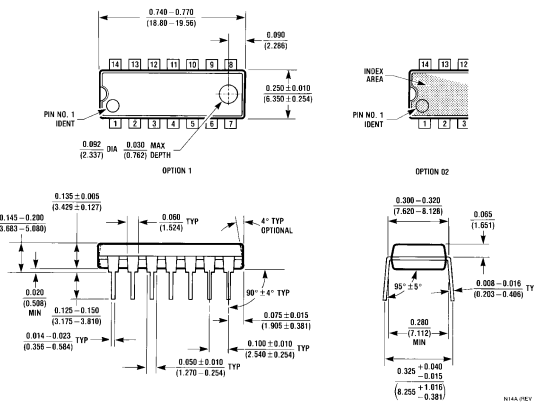

**Molded Dual-In-Line Package (N)**  
**Order Number CD4007MN or CD4007CN**  
**NS Package Number N14A**

**LIFE SUPPORT POLICY**

NATIONAL'S PRODUCTS ARE NOT AUTHORIZED FOR USE AS CRITICAL COMPONENTS IN LIFE SUPPORT DEVICES OR SYSTEMS WITHOUT THE EXPRESS WRITTEN APPROVAL OF THE PRESIDENT OF NATIONAL SEMICONDUCTOR CORPORATION. As used herein:

1. Life support devices or systems are devices or systems which, (a) are intended for surgical implant into the body, or (b) support or sustain life, and whose failure to perform, when properly used in accordance with instructions for use provided in the labeling, can be reasonably expected to result in a significant injury to the user.
2. A critical component is any component of a life support device or system whose failure to perform can be reasonably expected to cause the failure of the life support device or system, or to affect its safety or effectiveness.



**National Semiconductor Corporation**  
 1111 West Bardin Road  
 Arlington, TX 76017  
 Tel: 1(800) 272-9959  
 Fax: 1(800) 737-7018

**National Semiconductor Europe**  
 Fax: (+49) 0-180-530 85 86  
 Email: cnjwge@tevm2.nsc.com  
 Deutsch Tel: (+49) 0-180-530 85 85  
 English Tel: (+49) 0-180-532 78 32  
 Français Tel: (+49) 0-180-532 93 58  
 Italiano Tel: (+49) 0-180-534 16 80

**National Semiconductor Hong Kong Ltd.**  
 19th Floor, Straight Block,  
 Ocean Centre, 5 Canton Rd.  
 Tsimshatsui, Kowloon  
 Hong Kong  
 Tel: (852) 2737-1600  
 Fax: (852) 2736-9960

**National Semiconductor Japan Ltd.**  
 Tel: 81-043-299-2309  
 Fax: 81-043-299-2408

National does not assume any responsibility for use of any circuitry described, no circuit patent licenses are implied and National reserves the right at any time without notice to change said circuitry and specifications.

This datasheet has been downloaded from:

[www.DatasheetCatalog.com](http://www.DatasheetCatalog.com)

Datasheets for electronic components.