Syntax of Ditransitives

Heidi Harley, Linguistics, University of Arizona and Shigeru Miyagawa, Linguistics, MIT

<https://doi.org/10.1093/acrefore/9780199384655.013.186>

Published online: 29 March 2017

Summary

Ditransitive predicates select for two internal arguments, and hence minimally entail the participation of three entities in the event described by the verb. Canonical ditransitive verbs include *give*, *show*, and *teach*; in each case, the verb requires an agent (a giver, shower, or teacher, respectively), a theme (the thing given, shown, or taught), and a goal (the recipient, viewer, or student). The property of requiring two internal arguments makes ditransitive verbs syntactically unique. Selection in generative grammar is often modeled as syntactic sisterhood, so ditransitive verbs immediately raise the question of whether a verb may have two sisters, requiring a ternary-branching structure, or whether one of the two internal arguments is not in a sisterhood relation with the verb.

Another important property of English ditransitive constructions is the two syntactic structures associated with them. In the so-called “double object construction,” or DOC, the goal and theme both are simple NPs and appear following the verb in the order V-goal-theme. In the “dative construction,” the goal is a PP rather than an NP and follows the theme in the order V-theme-to goal. Many ditransitive verbs allow both structures (e.g., *give John a book/give a book to John*). Some verbs are restricted to appear only in one or the other (e.g. *demonstrate a technique to the class/*demonstrate the class a technique; cost John \$20/*cost \$20 to John*). For verbs which allow both structures, there can be slightly different interpretations available for each. Crosslinguistic results reveal that the underlying structural distinctions and their interpretive correlates are pervasive, even in the face of significant surface differences between languages. The detailed analysis of these questions has led to considerable progress in generative syntax. For example, the discovery of the hierarchical relationship between the first and second arguments of a ditransitive has been key in motivating the adoption of binary branching and the vP hypothesis. Many outstanding questions remain, however, and the syntactic encoding of ditransitivity continues to inform the development of grammatical theory.

Keywords: binary branching, c-command, verb alternations, nominalizations, idioms, clitics, applicatives, Japanese, Spanish, Myers’s generalization, selection

The ditransitive construction is associated with two internal arguments, theme and typically goal, though the second argument may also bear roles such as benefactive and ablative. In many languages, including English, the two internal arguments may occur in two distinct syntactic configurations, the dative construction and the double object construction (DOC):

(1)

a. *Dative construction*

John gave a book to Mary.

b. *Double object construction (DOC)*

John gave Mary a book.

Much of the generative linguistics literature on ditransitives has centered on attempting to understand how a single verb can host two internal structures, and on the difference in syntax and semantics between the dative and DOC constructions.

1. Structure for the Two Internal Arguments

The two constructions, the dative and the DOC, exhibit properties that are different—even opposite—of what one would normally expect. Consider the structure of the DOC, which has two DPs for the internal arguments (NPs in earlier literature). Two early hypotheses about its structure are illustrated below.

(2)

a. Oehrle (1976)

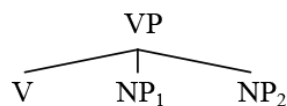

b. Chomsky (1981)

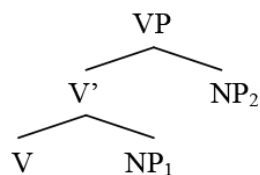

In the first structure (2a), the two NPs mutually c-command each other, while in the second (2b), the second NP, which is the theme, asymmetrically c-commands the first NP, the goal. However, Barss and Lasnik (1986) showed that in fact, in the DOC the goal (the first NP) asymmetrically c-commands the theme (the second NP). Their arguments were based on the behavior of constructions in which c-command has been shown to play a key role: anaphor binding, variable binding, weak crossover, and NPI licensing.

(3)

Anaphor

a. I showed Mary herself.

b. *I showed herself Mary.

(4)

Quantifier-pronoun

a. I gave every worker_i his_i paycheck.

b. *I gave its_i owner every paycheck_i.

(5)

Weak crossover

- a. Which man_i did you send his_i paycheck?
- b. *Whose_i pay did you send his_i mother t_i?

(6)

NPI licensing

- a. I showed no one anything.
- b. *I showed anyone nothing.

Based on these tests, Barss and Lasnik concluded that the relative relationship of the two internal arguments in the DOC must be the following, where the goal c-commands the theme.

(7)

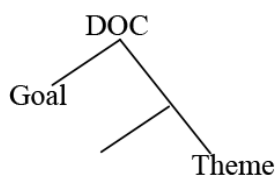

The dative construction also shows a c-command relation between the first internal argument, which in this construction is the theme, and the second internal argument, which in the dative is the goal PP, illustrated in (8) with quantifier binding. The other tests (anaphor, weak crossover, and NPI licensing) also point to the same conclusion.

(8)

I gave every paycheck_i to its_i owner.

(9)

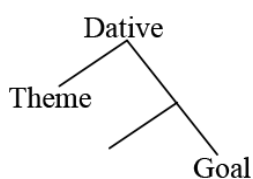

One complication with the dative construction is that inverse scope is also possible in variable binding (10), something not seen in the DOC (11). See further discussion at the end of section 6.

(10)

?I gave his_i paycheck to every owner_i. *Dative*

(11)

*I gave its_i owner every paycheck_i. *DOC*

2. Underlying Order

What is the underlying order of the constituents in each construction? In considering the dative construction, what one would expect is that the underlying order matches the surface order: verb-theme-PP_{goal}. However, the behavior of idioms suggests something different.

Idioms (Emonds, 1972; Larson, 1988):

(12)

- a. Lasorda *sent* his starting pitcher *to the showers*.
- b. Mary *took* Felix *to the cleaners*.
to task.
- c. Felix *threw* Oscar *to the wolves*.
- d. Max *carries* such behavior *to extremes*.

Assuming that idioms must be base-generated as a constituent in the underlying structure, these examples show that the underlying order of the dative construction must base-generate the goal PP adjacent to the verb, with subsequent movement deriving the surface order.

(13)

V-PP

We in fact find a proposal for this underlying structure in one of the earliest works on generative grammar.

(14)

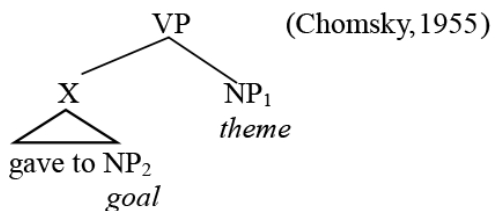

Notice that this structure also entails c-command of the goal by the theme, which is the conclusion suggested by the Barss and Lasnik (1986) tests on the dative construction. We will return to this proposal below.

What about the DOC? The surface order is verb-goal-theme, yet the idiom test indicates that the theme, which is the second argument on the surface, must be adjacent to the verb in the underlying structure (Larson, 1988).

(15)

Mary *gave* John *the boot*.

Thus, the idiom test suggests that the underlying order of the two constructions is opposite of what appears on the surface. See Bruening (2010b) for a thorough catalog and structural analysis of English idioms in ditransitive structures.

3. Meaning Differences

Do the two constructions, dative and DOC, have the same LF? That is, are they synonymous? Given that they both have essentially the same internal arguments, theme and goal, it would be reasonable to surmise that the answer is yes. However, the following contrast shows that while the DOC has some restrictions on what it can express, there is no such restriction on the dative construction (Green, 1974; Oehrle, 1976).

(16)

- a. #John sent Philadelphia a letter. *DOC*
- b. John sent a letter to Philadelphia. *Dative*

The apparent restriction is that the goal, which can essentially be anything in the dative construction, must be animate in the DOC. The reason is that in the DOC, the goal is presumed to represent the ultimate possessor of the entity represented by the theme. The possessor role requires a sentient being, thus animate. This constraint explains the existence of a well-formed reading of (16a) in which “Philadelphia” is taken as denote the ‘Philadelphia office,’ or a branch of a human organization, rather than the city of Philadelphia—the ‘Philadelphia office’ reading. The following contrast, constructed to highlight the difference in the available readings for the homophonous term [bɔrdər] in goal position, further illustrates this point. In the double object construction, only the human-referent interpretation of [bɔrdər] is available, while in the dative construction, both the human-referent interpretation and the physical-geopolitical-boundary interpretation are licensed.

(17)

- a. I sent the boarder/*the border a package. *DOC*
- b. I sent a package to the boarder/the border. *Dative* (Bresnan, 1978)

That is, the inanimate “border” is fine as the goal for the dative, but not for the DOC.

A second meaning difference between the two constructions was pointed out by Oehrle (1976):

(18)

- a. Nixon’s life gave Mailer a book.
- b. #Nixon’s life gave a book to Mailer.

The subject is not the agent, but rather the causer. Oehrle claims that this causative meaning only occurs in the DOC. However, Bresnan (2007) and (Snyder, 2003) point out that the dative construction may also exhibit such a causative meaning in examples such as (19):

(19)

Nixon's behavior gave an idea for a book to every journalist living in New York City in the 1970s.

Notice, however, that the dative goal argument here is a 'heavy' NP with a clausal modifier. Bruening (2010a) argues that this and similar examples are derived from a base-generated DOC via rightward movement, and that the *to* is the result of a syntactic repair operation, not the genuine prepositional element of the dative construction. If he is correct, such examples do not constitute counterexamples to Oehrle's generalization. See Section 7.3 for further discussion of the interaction of prosodic weight and the ditransitive alternants.

Although the behavior of ditransitives in English served as the foundation for initial research into their syntactic structure, crosslinguistic work soon brought other interesting patterns to the fore. Ditransitive structures exhibit significant variation and, importantly, significant commonalities, crosslinguistically (see Malchukov et al., 2010; Haspelmath, 2015 for recent typological overviews). Detailed syntactic investigation reveals that the structural variation and interpretive correlations which underlie the dative/DOC alternation can be observed even in languages where surface markings are not revealing.

4. Case, Clitic

In some languages with overt case marking, the marking on the goal varies, apparently signaling the different structures associated with the DOC versus the dative construction. These are often free-word-order languages, so the surface order is not as crucial as the adpositional versus case-only forms of the internal arguments in indicating the two different constructions.

Hiaki (Yaqui) (Jelinek, 1999; Jelinek & Carnie, 2003)

(20)

Hiaki (Yaqui) (Jelinek, 1999; Jelinek & Carnie, 2003)

a. 'Aapo Huan-ta-u 'uka vachi-ta maka-k
he John-ACC-to the.ACC corn-ACC give-PERF
'He gave the corn to John.'

b. 'Aapo Huan-ta 'uka vachi-ta miika-k
he John-ACC the.ACC corn-Acc give.food-PERF
'He gave John the corn (as a gift).'

Greek (Anagnostopoulou, 2003, p. 10)

(21)

Greek (Anagnostopoulou, 2003, p. 10)

- a. Dhidhaksa ghramatiki s-ta pedhia
taught.1SG grammar.ACC to-the children.ACC
'I taught grammar to the children.'
- b. Dhidhaksa ta pedhia ghramatiki
taught.1SG the children.ACC grammar.ACC
'I taught the children grammar.'

Japanese does not show the kind of alternation seen in Hiaki and Greek; instead, the goal is always marked with the dative *ni*, possibly due to the double-accusative constraint (e.g., Harada, 1973) that forbids two accusatives in the same clause. Nevertheless, it has been argued that the language exhibits two distinct constructions paralleling the DOC and the dative, depending on whether the goal is a possessor or a location (e.g., Kishimoto, 2001; Miyagawa & Tsujioka, 2004). If it is a possessor, its projection is a DP (DOC), but if it is a location, it is a PP (dative). Using numeral quantifiers, which can float off a DP but not a PP (Shibatani, 1977; Miyagawa, 1989), Miyagawa and Tsujioka (2004) note the following contrast in acceptability in quantifier float:

(22)

- a. Sensei-ga gakusei-ni futa-ri tegami-o okutta.
teacher-NOM student-NI 2-CL letter-ACC sent
'The teacher sent two students a letter.'
- b. *Daitooryoo-ga kokkyoo-ni futa-tu heitai-o okutta.
president border-NI 2-CL soldier-ACC sent
'The president sent soldiers to two borders.'

If Japanese is like English, the goal of the DOC is a DP, while the goal in the dative construction is a PP. In (22b), which has an inanimate goal ("border"), the impossibility of floating the numeral quantifier receives explanation if the *ni*-marked goal is a PP, which does not allow float. In contrast, (22a) has an animate goal that may be interpreted as a possessor, thus a DP, which would allow float to take place. So, in (22a), *ni* is a case marker, while in (22b) it is a postposition. Sadakane and Koizumi (1995) also give other arguments that the *ni* particle may represent either case or postposition. The overall picture is one in which the two structures for ditransitives are distinct crosslinguistically, even in the absence of clear morphological cues.

A similar pattern emerges in Spanish, in which ditransitives allow what appears to be optional clitic doubling with the goal. At first glance, there are no apparent signs of a distinction between the DOC and dative constructions in this language.

(23)

- a. Pablo *le* mandó un diccionario **a Gabi.**
Pablo CL.DAT sent a dictionary Gabi.DAT
'Pablo sent Gabi a dictionary.'
- b. Pablo mandó un diccionario **a Gabi.**
Pablo sent a dictionary Gabi.DAT
'Pablo sent a dictionary to Gabi.'

Cuervo (2003) argues, however, that clitic doubling is not purely optional, but rather, that its presence is diagnostic of the DOC as opposed to the dative construction. Again, this can be detected by combining clitic doubling with the animacy test.

(24)

- a. *Pablo *le* mandó un diccionario **a Barcelona.**
Pablo CL.DAT sent a dictionary Barcelona.DAT
'Pablo sent Barcelona a dictionary.'
- b. Pablo mandó un diccionario **a Barcelona.**
Pablo sent a dictionary to Barcelona
'Pablo sent a dictionary to Barcelona.'

With clitic doubling, the goal must be animate and cannot be "Barcelona," as shown in (24a). Hence clitic doubling apparently implicates the DOC. Without the doubling, as in (24b), there is no animacy restriction, suggesting that the lack of doubling represents the dative construction. (See also Anagnostopoulou, 2003 for discussion of the interaction of clitic constructions and ditransitives crosslinguistically.)

The data described above suggest that even when apparently morphologically identical, goal arguments are structurally distinct in the DOC and dative constructions. Of course, languages exhibit many different strategies with regard to case-marking the goal in a DOC. In many, (Japanese, English, Hiaki), the DOC goal receives a structural objective case, either accusative or dative. In others, such as German and Icelandic, it receives an inherent dative case (Woolford, 2006 and references therein). In Spanish, a DOC goal DP is marked with prepositional *a*, just as a dative goal DP is. In Ancient Greek, a DOC goal could bear either dative or genitive, depending on the verb (Anagnostopoulou & Sevdali, 2015). It is clear that a multifaceted set of diagnostics, which can vary from language to language, must often be brought to bear to determine the internal differences between the structures in a given language; a straightforward examination of the surface marking of the arguments does not suffice.

5. The Structure of Ditransitives

As shown earlier, in both the DOC and dative constructions in English, the first of the two internal arguments asymmetrically c-commands the other. In the case of the DOC, it is the goal that c-commands the theme, and in the dative construction, it is the theme that c-commands the goal PP. The first focus will be the dative construction. Along with the c-command relationship of theme > goal PP, the idiom test showed that in the dative

construction, the goal PP, which is distant from the verb on the surface, apparently forms a constituent with the verb underlyingly. As noted above, this has long been recognized (Chomsky, 1955; Bach, 1979; Dowty, 1979; Jacobson, 1983, 1987; Larson, 1988; Marantz, 1993); these two points were captured in the analysis of the dative construction proposed in one of the earliest studies in the generative tradition:

(25)

Chomsky, 1955 (*Logical Structure of Linguistic Theory*)

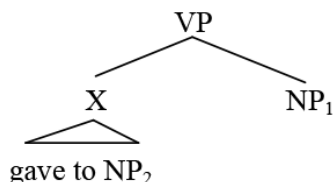

The theme, NP₁, c-commands the goal (*to* NP₂), and the goal PP occurs adjacent to the verb. Some movement operation would then necessarily derive the surface constituent order, [V NP₁ *to* NP₂]. In Categorical Grammar/Montague Grammar, the operation of “right wrap” gives this result for the surface form (Bach, 1979; Dowty, 1978; Jacobson, 1983).

A later approach to the dative construction was the VP shell proposal of Larson (1988), where the theme is base-generated on the left of the V-goal constituent and the surface order of the verb and theme is derived via head-movement (26).

(26)

VP Shell (Larson, 1988)

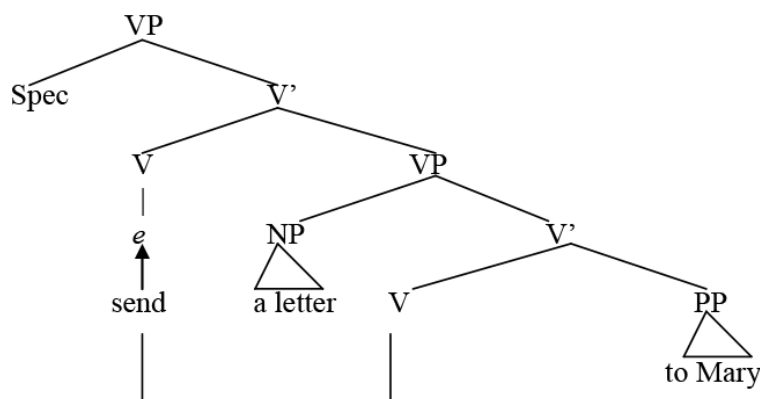

This proposal captures both points about the dative construction as well. The theme occurs in the specifier of the VP projected from the ditransitive verb, and the PP is the complement of the verb. The theme asymmetrically c-commands the goal PP, and the goal PP forms a constituent with verb to start with. This proposal puts the theme and the goal both in the same VP constituent, and as Larson notes, the theme-goal combination may occur as conjoined constituents.

(27)

- a. John sent [a letter to Mary] and [a book to Sue].
- b. I gave [dollars to Maxwell] and [three dollars to Chris].

(Larson, 1988)

Larson proposes that the verb raises to a higher position, which has been created with an empty head, thus a “VP shell.” Larson’s proposal has been highly influential in a number of ways. It shows that by postulating two head positions, the correct asymmetric c-command relation between the two internal arguments can be captured, a point that is explicitly developed in Marantz (1993) and in subsequent works discussed below. The proposal also suggests that not all structure needs to project from lexical items, and that there may be structures built independently into which a lexical item is inserted. This, as well as other features of his approach, was one important motivation for ridding the theory of the notion of deep structure (e.g., Chomsky, 1993, 1995).

For the DOC, there are two major approaches. One is an approach in which the DOC is derivationally related to the dative construction (Baker, 1988; Larson, 1988; Levinson, 2004; Ormazabal & Romero, 2010). For example, Larson (1988) presents an analysis of the DOC that begins with the dative VP-shell structure above, and derives the DOC via ‘passivization’ of the verb in the lower VP shell, hence suppressing its subject, the theme argument, and promoting its complement, the goal argument, to specifier position.

The other approach proposes that the DOC is derivationally independent of the dative construction (Marantz, 1993; Pesetsky, 1995 et seq.). In this approach, typically some additional head is posited that introduces the goal DP, an idea that originates in Marantz (1993), who postulated an applicative head for the DOC, and is taken up in a considerable amount of later work (e.g., Collins, 1997; McGinnis, 1998; Anagnostopoulou, 2003; Pylkkänen, 2002, 2008; Miyagawa & Tsujioka, 2004; Bruening, 2010b; etc.).

(28)

The applicative head hypothesis

The DOC includes an applicative head (Marantz, 1993).

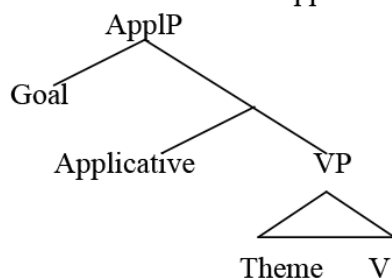

The original motivation for this comes from languages that have an overt incorporated applicative head that makes an extra goal argument possible. The following is an example from Chichewa.

(29)

Chichewa applicative construction

(Alsina & Mchombo, 1990, as given in Marantz, 1993)

Chitsiru chi-na-gul-ir-a atsikana mphatso.

fool SP-pst-buy-APPL-fv girls gift

'The fool bought the girls a gift.'

In another version of the derivationally independent approach, the DOC involves a caused-possession structure, resurrecting the older 'cause to have' analysis of the DOC from the generative semantics literature (e.g., Green, 1974; Oehrle, 1976). A causative 'light' verb selects for an embedded null predicate (den Dikken, 1995; Pesetsky, 1995; Collins & Thrainsson, 1996; Harley, 1995, 2002), sometimes also identified with a hypothetical possessive preposition incorporated in possessive verbs like *get*, *have*. Harley's version of this proposal is illustrated in (30) below; Pesetsky's in (38) follows:

(30)

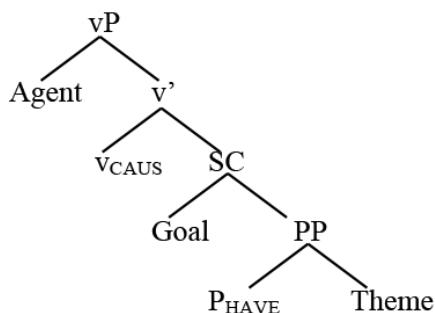

Such proposals, in which the goal of a DOC is introduced by a dedicated head, comport well with the proposal of Woolford (2006) concerning the inherent dative case assigned to DOC goals in languages like German and Icelandic. Woolford argues that the regularity of the correspondence between the goal thematic role and inherent dative case in such languages can be accounted for if DOC goals are introduced by a particular functional projection, which itself assigns inherent dative case (though see Biggs, 2014 for a counterproposal).

All of these proposals capture the structural hierarchical asymmetry discovered by Barsa and Lasnik (1986) between the two arguments of ditransitives in both constructions, and are hence explanatorily adequate in that regard. However, one corner of the empirical picture of the hierarchical relations which has not been thoroughly addressed by each approach needs to be emphasized. The general mirror-image picture of the DOC and dative constructions that emerges from most c-command tests comes apart in one direction when it comes to quantifiers. As noted in (10) and (11), although inverse binding of a pronoun by a quantifier is impossible in the DOC, it is possible in the dative construction. Importantly, this correlates with the availability of inverse quantifier scope between the theme and goal in the dative (31), but not in the DOC (32), as well:

(31)

I gave a bone to every dog. $\exists > \forall$, $\forall > \exists$ Dative

(32)

I gave a dog every bone. $\exists > \forall$, $\forall \neq \exists$ *DOC*

This asymmetry is addressed in some detail by Bruening (2001), but has not been much addressed elsewhere. Given that inverse scope is typically treated via covert A'-movement, Bruening concludes that in the DOC the goal/theme pair must obey superiority throughout, while the dative construction must include an 'escape hatch' of some kind, thus allowing a quantified goal to optionally move to a position where it outscopes the theme. As noted in den Dikken (2005), this asymmetry is particularly significant in that it informs the correct formulation of syntactic locality as well as the structure of the two varieties of ditransitive construction. The different approaches to the DOC and dative constructions outlined above have distinct implications for the nature of the escape hatch introduced by the dative. Collins and Thrainsson (1996) also demonstrated that object shift of both internal arguments in Icelandic DOCs must obey superiority, and also argued for a locality-based explanation of the pattern. The correct analysis of ditransitives, then, has the potential to sharply constrain the hypothesis space about economy conditions on movement.

Another important aspect of the empirical picture is the interaction of ditransitives and nominalizations; the analyses described above will now be described in relation to it.

6. Nominalization Asymmetries

Kayne (1984) observed a difference in the nominalization properties between the dative construction and the DOC. This difference is not easily accounted for by some of the earlier proposals discussed. Pesetsky's (1995) morphological analysis (section 6.1) will be introduced, as will the selectional approaches of Harley (2002) and Bruening (2010b) (Section 6.2).

In deverbal nominalization, the internal argument of the verb may typically surface inside an *of*-phrase or as the genitive of the resulting NP (Kayne, 1984).

(33)

- a. examine the problem =>
- b. the examination of the problem
- c. the problem's examination

Neither of these possibilities arises if the DP is the subject of a small clause.

(34)

- a. believe Thilo handsome =>
- b. *the belief of Thilo handsome
- c. *Thilo's belief handsome

Kayne deduces from these facts that only an argument may occur in the *of*-phrase and the genitive position in deverbal nominalization.

Kayne then turns to the ditransitive constructions and shows that in the dative construction, the first DP, the theme, behaves as the verb's argument. It can occur with *of* and it can also occur as the genitive DP.

(35)

- a. present the ball to John =>
- b. the presentation of the ball to John
- c. the ball's presentation to John

In contrast, the first DP following the verb in the DOC, which is the goal DP, is not the argument of the verb. It cannot occur with *of*, and it cannot occur in the genitive position.

(36)

- a. present John the ball =>
- b. *the presentation of John of the ball
- c. *John's presentation of the ball

Kayne suggests that in the DOC, the two internal arguments constitute a small clause, which has already been observed as being unable to be the source of deverbal nominalization.

(37)



One question that arises for this analysis is, what precisely is the status of the two DPs? If they are not the arguments of the ditransitive verb, where do they get their semantic roles?

6.1. A Morphological Account of the Nominalization Asymmetry

Motivated in part by Kayne's observations about deverbal nominalization, Pesetsky (1995) proposes an alternative to the small clause analysis that crucially utilizes zero morphemes. He postulates an abstract preposition, called *G* for "goal," for the DOC. The idea is that both constructions, the DOC and the dative, contain a "goal" preposition, but in the DOC it is phonetically null, which is a crucial component of his analysis.

(38)

a. Double object

(Pesetsky, 1995, 155–156; the nodes have been labeled based on structures given in Pesetsky, 1995, 126–127)

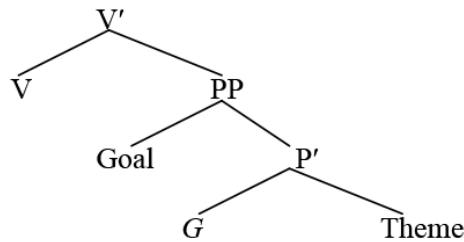

b. *To* dative

(Pesetsky, 1995, p. 174; slightly modified)

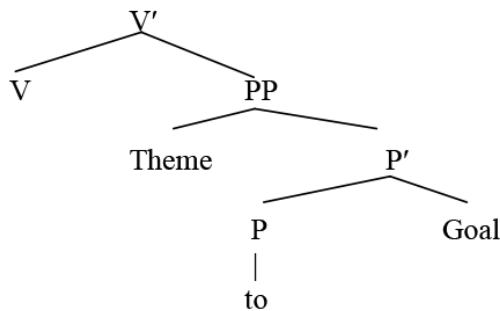

In addition, Pesetsky proposes that *G* in the double-object construction undergoes incorporation into the verb, similar to preposition incorporation in many languages (e.g., Baker, 1988); the assumption is that *G* is a dependent morpheme and must be incorporated.

(39)

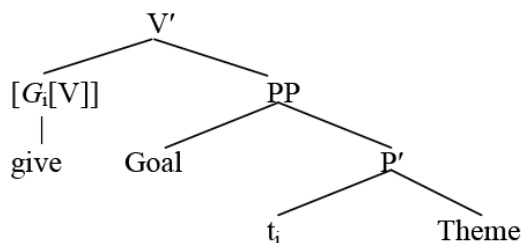

There are two different verbs *give*, one that contains the zero morpheme *G* and is associated with the DOC, and the other that lacks this morpheme and is associated with the dative construction.

(40)

*give*₁ [*G*[*V*]]: DOC
*give*₂ [*V*]: Dative construction

To explain the nominalization facts, Pesetsky turns to Myers's Generalization.

(41)

Myers's Generalization (Myers, 1984)

Zero-derived words do not permit the affixation of further derivational morphemes.

The double-object verb is a zero-derived word because it contains the zero morpheme *G*. As a result, it cannot undergo further derivational processes such as nominalization. In contrast, the dative-construction verb contains no zero morpheme that attaches to it in the normal course of derivation, so there is nothing to prevent its nominalization.

Pesetsky argues that Myers's Generalization can also account for the pattern of nominalization involving lexical causatives noted in Chomsky (1970).

(42)

- a. John grew tomatoes (in his backyard).
- b. Tomatoes grew (in John's backyard).

(43)

- a. *John's growth of tomatoes
- b. the growth of tomatoes

As shown in (43a), the deverbal nominalization of the lexical causative in (42a) is ungrammatical, while the deverbal nominalization of the unaccusative counterpart of the lexical causative is fine (43b). Chomsky (1970, p. 25) notes that the unaccusative *the growth of tomatoes* "has the interpretation of *tomatoes grow* but not of *John grows tomatoes*." Chomsky suggests that while the unaccusative sentence has the structure in (44), the structure of the lexical causative sentence is (45).

(44)

Tomatoes grow: [_S tomatoes grow]_S

(45)

John grows tomatoes: John [+cause, grow] tomatoes (Chomsky, 1970, p. 59)

Chomsky argues that the combining of +cause and *grow* is a lexical process. But suppose that it is the result of syntactic derivation.

(46)

John [+cause] [_S tomatoes grow]_S
 ↑ |

This would be an instance of zero-derivation, hence Myers's Generalization correctly predicts that the English lexical causative cannot nominalize. Assuming that the unaccusative variant has no zero morpheme, the unaccusative counterpart may readily nominalize.

6.2. -kata Nominalization in Japanese and Myers's Generalization

In Japanese, the nominal head *-kata* 'way' occurs in nominalization of a clause (Kageyama, 1993; Sugioka, 1992; Kishimoto, 2006).

(47)

Taroo-no syokudoo-de-no piza-no tabe-kata
Taro-GEN cafeteria-in-GEN pizza-GEN eat-way
'Taro's way of eating pizza in the cafeteria'

This is a nominalization of the sentence in (43).

(48)

Taroo-ga syokudoo-de piza-o tabe-ta.
Taro-NOM cafeteria-in pizza-ACC ate
'Taro ate pizza in the cafeteria.'

As can be seen above, DPs that serve as arguments in the sentence in (48) receive the genitive *no* directly in the nominalization counterpart in (47). Kageyama (1993) argues convincingly that this nominalization is a syntactic process by the fact that syntactic elements such as aspectual marking, passive, and causative are contained in the nominal.

(49)

- a. sake-no nomi-hazime-kata
sake-GEN drink-begin-way
'the way of starting to drink sake'
- b. yom-ase-hazime-kata
read-CAUS-begin-way
'the way of making (someone) start to read'
- c. (zidaigeki-de-no) akuyaku-no kir-are-kata
(period-play-in-GEN) villain-GEN cut-PASS-way
'villains' way of being cut (with a sword) (in period plays)'

Miyagawa (2012) extended the important analysis of this nominalization construction in Kishimoto (2006). The following gives further support to the idea that even in Japanese, the dative construction and the DOC exist as separate constructions.

(50)

- a. *Hanako-no John-no MIT-no susume-kata
Hanako-GEN John-GEN MIT-GEN recommend-way
- b. Hanako-no John-e-no MIT-no susume-kata
Hanako-GEN John-to-GEN MIT-GEN recommend-way
'Hanako's way of recommending MIT to John'

In (45a), all phrases directly have the genitive marking; crucially for the goal *John*, this marks it as a DP, hence a part of the DOC. The fact that the nominalization is impossible parallels what Kayne (1984) pointed out for the English DOC. In (45b), with the postposition *e* 'to,' the construction is dative; hence nominalization is possible, again paralleling Kayne's observation. On Pesetsky's analysis, the verb in (45a) has been zero-derived, which blocks nominalization.

Thus far, Japanese parallels English. However, the lexical causative shows a very different situation. In English, a lexical causative construction does not allow nominalization (Chomsky, 1970). However, as noted by Kageyama (1993), in Japanese the causative construction readily allows nominalization. The example is repeated here.

(51)

yom-ase-hazime-kata
read-CAUS-begin-way
'the way of making (someone) start to read'

As noted in Miyagawa (2012), this contrast between English and Japanese is predicted by Pesetsky's analysis based on Myers's Generalization. In English, the lexical causative is the result of zero-derivation involving a zero causative morpheme. But in Japanese, the causative morpheme has phonological content, so Myers's Generalization does not block its nominalization.

6.3 Selectional Accounts of the Nominalization Asymmetry

Although the morphological account of the failure of nominalization for the DOC has some explanatory power, subsequent alternative approaches have called the importance of zero-derivation into question, instead focusing on the notion that selectional constraints are at work in determining whether a given argument may appear in a nominalization, and calling into question the notion that zero-derivation is indeed a barrier to further affixation.

Marantz (1997) and Harley and Noyer (2000) emphasize that the impossibility of nominalization of a given causative verb has a great deal to do with the lexical semantics of the causative verb in question, namely, whether an agentive reading of the nominalized VP is possible. Consider the following contrast:

(52)

- a. John's accumulation of wealth occurred over several years.
- a'. John accumulated wealth over several years.
- a''. Wealth accumulated over several years.
- b. #The book's accumulation of dust occurred over several years.
- b'. The book accumulated dust over several years.
- b''. Dust accumulated over several years.

This pattern suggests that the failure of agentive nominalization of causative *growth* may not have to do with the presence or absence of a zero morpheme in the nominalized verb (since such a morpheme presumably exists in causative *accumulate* in (52a') above), but more to do with the potential interpretations available to the possessor of an event nominalization.

In addition to English and Japanese, it has been shown that the DOC also cannot undergo nominalization in Korean (Kim, 2015). Kim argues that a Myers's-generalization approach to this pattern is difficult to maintain in that language, since Korean nominalizations routinely include null morphemes such as voice. Without Myers's generalization, then, how can the failure of nominalization of the DOC be explained, in contrast to the dative construction?

An alternative account builds on the idea that a nominalizing suffix must select directly for a projection of the verb it nominalizes (Bruening, 2010b; Kim, 2015, among others). Under an applicative view of the structure of double object constructions, like that first introduced in Marantz (1993) and illustrated in (28) above, the nominalizing suffix cannot apply to the DOC, since the DOC necessarily includes the applicative head that introduces the goal argument. That is, the verbal selectional constraint on the complement of nominalization cannot be met (53a). In contrast, in the dative construction, the verb root itself selects for both theme and goal arguments. Consequently, the dative construction can indeed undergo nominalization (53b):

(53)

a. *Nominalization of DOC *give*

b. Nominalization of dative *give*

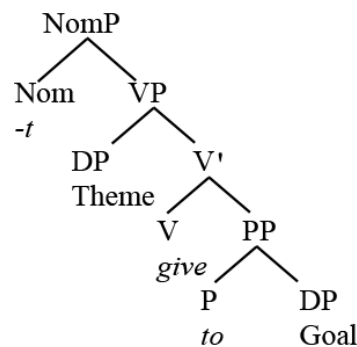
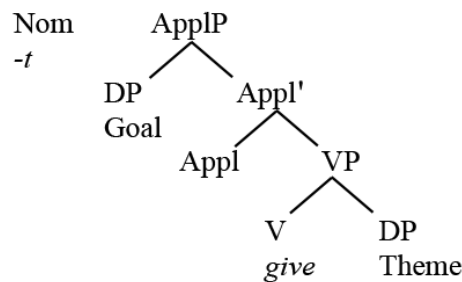

Head-movement of V to Nom plus last-resort introduction of inherent genitive *of* generates the final form *gift (of) theme to goal* in (53b). In (53a) the structure cannot arise, since Nom cannot select for ApplP.

Pesetsky's (1995) G approach or Harley's (2002) P_{HAVE} approach could adopt a similar account of the failure of nominalization of the DOC, given that the incorporating G or P_{HAVE} head is a prepositional small clause, not a verbal projection (see (30) and (38) above). On such an approach, however, Harley's (2002) analysis would also predict, contrary to fact, that nominalization of the dative construction should also fail, since the dative construction also contained a fundamentally prepositional small-clause construction, with the relevant preposition in the dative construction representing a locative relation rather than a possession relation (see discussion in Bruening, 2010b; Kim, 2015). It is clear that a selectional view of the nominalization pattern implicates a low position of base-generation of the verb root in the dative, where it can select for both the theme and the goal. For further discussion of issues of category and selection within the extended verbal projection, see Wood and Marantz (2015).

6.4 Applicative versus Small Clause Approaches to the DOC

For Pesetsky (1995) and Harley (2002), the prepositional predication that forms the heart of the DOC is like Kayne's small clause. The preposition encodes a possession relation, and the verb itself is base-generated as a modifier of the verbalizing causative *v* head which selects it, hence the 'caused-possession' interpretation of the DOC. In contrast, in Marantz's (1993) ApplP approach, developed most thoroughly by Bruening (2010b), the verb is base-generated low in the structure as the complement of the Applicative projection which introduces the goal argument. The possession relation arises from the presence of this ApplP.

Harley and Jung (2015), building on Kayne's (1993) original insights into the internal structure of *have*, argue that the parallels between the constraints on DOC goals and the subject possessor arguments of the verb *have* strongly suggest that the same possessive relation is involved in both. For example, as illustrated in (16) and (17) above, DOC goals generally must be animate, with one exception: the goal can be inanimate when the theme is inalienably possessed (55a). The same pattern of facts arises in *have* predications: inanimate subjects of *have* are only possible when the theme is inalienably possessed (55b).

(54)

- a. *The advertiser gave the car a flyer.
- b. *The car has a flyer.

(55)

- a. The painter gave the house a new coat of paint.
- b. The house has a new coat of paint.

Several other interpretive parallels between the DOC and verbal *have*, for example in idiomatic interpretations (Richards, 2001) and depictive modification (Harley & Jung, 2015), suggest that a unification between the internal structures for the DOC and the possessive verb *have* has some explanatory power for at least the English facts. To predict the existence of such parallels in the applicative-based view of the DOC, a null applicative head would also have to occur in the underlying structure for the verb *have*. Perhaps then the two theories may be notational variants (modulo the position of base-generation of the verb root). Given the connections between applicative constructions and prepositional constructions crosslinguistically, such a unification of the analyses does not seem implausible, and may potentially be insightful.

7. Constraints on the Dative/DOC Alternation

A key puzzle concerning the relationship between the dative and the DOC has to do with the degree to which a given ditransitive verb can productively occur with both structural variants. Many studies both within and outside the generative framework have noted that there are morphological, lexical-semantic, prosodic, and discourse-related constraints on the distribution of the alternation, and the latter two areas have seen an explosion of work in recent years.

7.1 Morphological Constraints

English has two morphological types of ditransitive verb, conforming for the most part with its historically bifurcated lexicon. Typically, etymologically Anglo-Saxon ditransitive verbs participate productively in both the DOC and dative structures, while etymologically Latinate ditransitives occur only in the dative structures and resist the DOC configuration. Consider the pairs in (56) below, adapted from Pesetsky (1995):

(56)

DOC	Dative
a. Bill sent Sue his regards.	Bill sent his regards to Sue.
a'. *Bill conveyed Sue his regards.	Bill conveyed his regards to Sue.
b. Mary showed Sue her findings.	Mary showed her findings to Sue.
b'. *Mary exhibited Sue her findings.	Mary exhibited her findings to Sue.
c. Tom told Ben the story.	Tom told the story to Ben.
c'. *Tom recounted Ben the story.	Tom recounted the story to Ben.
d. Nikki found Lauren the money.	Nikki found the money for Lauren.
d'. *Nikki collected Lauren the money.	Nikki collected the money for Lauren.

The pattern is robust, and, since speakers of English do not have direct access to the history that distinguishes the two classes of verbs, must depend on features of each verb that are accessible in the input. The core intuition is that the prosodic differences between the two classes—Anglo-Saxon verbs being primarily trochaic, Latinate ones being primarily iambic—somehow affects the ability of the verb to participate in the double object construction. A directly prosodic account was proposed by Grimshaw and Prince (1986) and Grimshaw (2005), and a morphological-selection account by Pesetsky (1995), according to which the null G morpheme imposes restrictions on the prosodic shape of its host. The prosodic-constraint hypothesis was investigated experimentally by Gropen et al. (1989) and more recently by Coppock (2008), both with some positive results.

An alternative interpretation, however, is suggested by Harley (2008, 2009), according to which the prosodically unusual Latinate verbs are bimorphemic, consisting of a verb root (e.g., *√hibit*) which is lexically constrained to incorporate a particular particle (e.g., *ex-*) from a small clause complement, much like an English verb-particle construction (e.g., *show off*) This bimorphemic structure is responsible for both their iambic prosodic structure and their inability to occur in the DOC. According to Harley's (1995, 2002) view of the DOC, the possession-expressing P_{HAVE} preposition in the small clause complement to *give* occupies the same slot as resultative particles in verb-particle constructions. Treating Latinate verbs as synchronically composed of a verb with an incorporated particle, then, accounts for their inability to occur in a DOC: Their particle slot is lexically specified, and P_{HAVE}' occupying the same position in the structure, is in complementary distribution with such particles. Typical English verb-particle constructions cannot occur in the DOC (**show Mary off the painting* versus *show the painting off to Mary*). See Punske (2013) for further refinement of this approach, and Levinson (2004) for an alternative analysis. Basilico (2008) argues that this prohibition does not hold for certain benefactive forms of the DOC. Nonetheless, Harley's proposal succeeds in unifying the largely parallel verb-particle prohibition on DOC structures with the Latinate prohibition on DOC structures in the synchronic grammar of English.

7.2 Lexical Semantic Constraints

A significant body of research has addressed the question of the influence of the ditransitive verb's lexical semantic content on its participation in the alternation. Rappaport Hovav and Levin (2008) make a detailed cross-linguistic case that the dative frame can be associated with either a 'caused motion' or a 'caused possession' interpretation, while (in agreement with previous findings) the DOC frame is constrained to express 'caused possession.' These distinctions are shown to account for the patterns of alternation exhibited by different lexical semantic classes of ditransitive verbs.

The three classes of verbs discussed by Rappaport-Hovav and Levin (2008) (and later by Levin, 2009) are the *give*-class, the *throw*-class, and the *send*-class. Verbs of the *give*-class are purely caused-possession verbs. Even when they occur in the dative frame, they do not license inanimate goals (**John gave the book to the table*), and the resulting possession of the theme by the goal is not merely implicated but entailed. Verbs of the *send*-class have both caused-possession and caused-motion readings, and only the dative frame can be associated with the caused-motion reading. Verbs of the *throw*-class also have both caused-possession and caused-motion readings, and again only the dative frame can be associated with the caused-motion readings. Ditransitive verbs which only have the caused-motion reading—*push*, *pull*, *carry*, even *put*—cannot occur in the DOC frame.

Although it is well understood that not all verbs which occur in the dative frame allow the DOC alternation, and that both morphological and lexical semantic factors are relevant, it is perhaps less recognized that there are verbs which occur in the DOC alternation which may not occur in the dative frame. These verbs involve *prevention* of possession, and include *cost*, *spare*, and (for some) *deny*:

(57)

- a. The accident cost John \$2,000.
- b. *The accident cost \$2,000 to John.
- c. Can you spare John \$10?
- d. *Can you spare \$10 to John?
- e. Ann denied Beth the ice cream.
- f. %Ann denied the ice cream to Beth.

Krifka (2001) proposes that the constraint against representing negative possession in the dative frame has to do with the event structure of the negative possession schema. If the dative frame necessarily entails the existence of a caused event, the absence of the dative frame with these verbs may be a consequence of their lexical semantics, since there is no event of the ice cream not moving to Beth. Harley and Jung (2015) note another special property of this class of DOC verbs: they also form V-Theme idioms, like *cost (DP) an arm and a leg* (= "cost (DP) a lot of money"). This distinguishes them from alternating DOC verbs, which Harley and Jung (2015) claim form only P_{HAVE}-Theme idioms of the type identified by Richards (2001).

A series of investigations of the caused-possession interpretation of the DOC frame in recent years has focused on one of the most puzzling aspects of the construction, the defeasibility of the possession entailment. With *give* and one or two other 'core' caused-possession verbs, the

assertion of the verb entails the possessive relationship, but with most DOC verbs, the possessive relationship is merely implicated, so that continuations of DOC sentences like *Mary mailed Sue the sweater (but she never received it)* are perfectly sensible. If the DOC is a caused change-of-state construction, the lack of a possessive entailment is somewhat puzzling. Several researchers have proposed that many DOC constructions involve a modal component rather like progressive aspect, such that in the absence of contradicting information, the result possessive state is implicated, but the inclusion of the modal ensures that it is not entailed. See Koenig and Davis (2001), Beck and Johnson (2004), Beavers (2011), and Kratzer (2013) for treatments of the failure of possession entailments along these lines.

Lexical semantic constraints on ditransitive alternations interact with the morphological constraints in poorly understood ways. Pinker (1989) observed that one class of ditransitive verbs, the ‘verbs of future having’ (see Levin, 1993), include Latinate verbs with complex prosody such as *promise*, *bequeath*, *allocate*, and *guarantee*, which occur in the DOC despite their prosody. Such predicates not only fail to entail caused possession, they lexically encode future modality so as to explicitly deny that caused possession occurs simultaneously with the event described by the verb. It is surely not a coincidence that this complex semantic content correlates with exceptional syntactic behavior, but the reason for this correlation is not understood.

7.3. Information-Structural and Sentential Prosody Constraints

Besides qualities of the verb itself, many other factors have been argued to enter into the choice of frame for alternating ditransitive verbs. It has long been recognized that pronominal goals are more likely to appear in the DOC than in the dative construction, and that the inverse is true for heavy-NP goals (Givón, 1984). Both of these properties have been linked to information structural constraints according to which given or old information appears earlier in an utterance and focused or new information is more felicitous towards the end of an utterance. This view resonates with Kayne’s idea that the typical position of a goal in a DOC is the ‘inner subject’ of a small clause. Subjects are also typically topics, that is, old information. If the DOC is a small clause, then the correlation between information status, pronominal status, and (non-) heavy-NP characteristics may all derive from the fact that in the DOC there is a subject-predicate relation with the goal in subject position. See Basilico (2003) for some relevant discussion.

Others have interpreted similar results purely prosodically, in terms of an OT ‘end weight’ constraint, as demonstrated by Anttila et al. (2010) and further developed by Shih (2014). The latter argues that choice of syntactic structure is partially motivated by rhythmic well-formedness constraints that are active during speech planning, and suggests that assignment of prosody must feed the morphosyntactic production process, or at least occur simultaneously with it.

In addition to animacy of the goal, discussed in section 4, animacy of the theme has also been shown to be relevant to choice of alternant. Levin (2009) shows that animate themes trigger the dative construction, since caused possession is typically infelicitous when the theme is

animate, and uses this as a test to diagnose verb classes crosslinguistically: since animate themes with ditransitive verbs will generally only occur in the dative construction, verbs which permit or prefer the dative will be grammatical in such contexts.

Bresnan et al. (2007), however, argues against the notion that caused possession versus caused motion is deterministic in terms of choice of frame for alternating verbs (or, indeed, against the idea that there's anything wholly deterministic about ditransitives at all). In corpus searches, they found that several varieties of ditransitive expression which have been uncritically reported in the literature as categorically requiring one or the other frame do in fact occur in the 'wrong' frame when other factors conspire to override the lexical preference. For example, expressions like *give NP the creeps* are usually claimed to be ungrammatical in the Dative **give the creeps to NP*. Bresnan et al.'s search, however, turned up natural examples like the following:

(58)

Stories like these must give [the creeps] [to people whose idea of heaven is a world without religion].

Consequently, Bresnan proposes a completely probabilistic model of the choice of DOC or dative, where core meaning components like 'caused possession' are among many interacting factors which motivate the final choice of frame during a given speech act.

With regard to examples like (58), however, it is worth noting that Bruening (2010a) argues strongly that heavy NP-shift (and other constructions) applied to a DOC goal results in the insertion of 'to,' thus disguising what is underlyingly a DOC as a dative. It is conceivable that the counterexamples of the type in (58) identified by Bresnan and others could be the product of this *to*-insertion process. The preposition *to*, like Japanese *-ni*, would then have a double life, functioning as a true preposition in some cases and as a case marker or morphological repair in other cases. Hallman (2015) makes a related proposal, bringing data from purpose clauses to bear on the debate. (See also Levin's (2009) discussion of syncretism in dative and allative case markers crosslinguistically.)

8. Overview and prospects

The puzzle of ditransitive constructions played a formative role in motivating important hypotheses in modern syntactic theory, and considerable strides have been made in understanding since. The importance of ditransitives for generative theory was first highlighted when they were used to illustrate the logical problem of language acquisition in a rather pure form ('Baker's Paradox,' Baker, 1979). That is, adult speakers of English converge on negative exceptions to the dative alternation (e.g., the restriction on Latinate verbs) without positive evidence from which to generalize. Later, the analysis of ditransitives led to the adoption of the binary-branching hypothesis and the discovery of the bipartite verb phrase in the early 1990s, a particularly rich and productive vein of research. Most recently, ditransitive structures have stimulated a large body of crosslinguistic research into the structure of applicative constructions.

Several advances have been made in the last 30 years. There is now a good understanding of the hierarchical relations between the two internal arguments. A relatively broad consensus has been reached that the DOC and dative alternants represent distinct underlying structures that are not derivationally related to each other (*pace* Ormazabal & Romero, 2010). The existence of DOC effects in languages with free word order and no unique morphological signature for the construction has been confirmed. The role of clitics in licensing the DOC variant has been recognized. Significant patterns in the distribution of idioms in ditransitives have been discovered, and some DOC idioms have been linked to other expressions of possession. The study of the alternation has now extended beyond the domain of pure competence to that of performance, with the application of online experimental methods and corpus-based research. Formal semantic tools have been brought to bear on aspects of the construction.

Yet no end is in immediate sight. The crosslinguistic picture of variation is still being filled out. The debate over the extension of the applicative structure to the morphologically unmarked DOC is not yet resolved. The relationship of prosodic, information-structural, semantic, and syntactic conditions on the use of the two alternants has not yet been clearly addressed in generative frameworks. As with many topics, the more that is known about ditransitive constructions, the more can be asked.

Further Reading

- Barss, A., & Lasnik, H. (1986). A note on anaphora and double objects. *Linguistic Inquiry*, 17, 347-354.
- Bruening, B. (2001). QR obeys superiority: Frozen scope and ACD. *Linguistic Inquiry*, 32, 233-274.
- Bruening, B. (2010a). Double object constructions disguised as prepositional datives. *Linguistic Inquiry*, 41(2), 287-305.
- Bruening, B. (2010b). Ditransitive asymmetries and a theory of idiom formation. *Linguistic Inquiry*, 41(3), 519-562.
- Chomsky, N. (1970). Remarks on nominalization. In R. Jacobs & P. Rosenbaum (Eds.), *Readings in English transformational grammar*. Waltham, MA: Ginn and Company.
- Gropen, J., Pinker, S., Hollander, M., Goldberg, R., & Wilson, R. (1989). The learnability and acquisition of the dative alternation in English. *Language*, 65, 203-257.
- Harley, H., & Jung, H.-K. (2015). In support of the P_{HAVE} approach to the double object construction <http://dx.doi.org/10.1162/LING_a_00198>. *Linguistic Inquiry*, 46(4), 703-730.
- Larson, R. (1988). On the double object construction. *Linguistic Inquiry*, 19, 335-391.
- Levin, B. (2008). Dative verbs: A crosslinguistic perspective. *Linguisticæ Investigationes*, 31, 285-312.
- Marantz, A. (1993). Implications of asymmetries in DOC. In S. Mchombo (Ed.), *Theoretical aspect of Bantu grammar* (pp. 113-150). Stanford, CA: CSLI.

-
- Miyagawa, S., & Tsujioka, T. (2004). Argument structure and ditransitive verbs in Japanese. *Journal of East Asian Linguistics*, 13, 1–38.
- Oehrle, R. (1976). *The grammatical status of the English dative alternation* (Unpublished PhD diss.). MIT, Cambridge, MA.
- Pesetsky, D. (1995). *Zero syntax: Experiencers and cascades*. Cambridge, MA: MIT Press.
- Pylkkänen, L. (2008). *Introducing arguments*. Cambridge, MA: MIT Press.
- Rappaport-Hovav, M., & Levin, B. (2008). The English dative alternation: The case for verb sensitivity. *Journal of Linguistics*, 44, 129–167.
- Richards, N. (2001). An idiomatic argument for lexical decomposition. *Linguistic Inquiry*, 32, 183–192.
- Woolford, E. (2006). Lexical case, inherent case, and argument structure. *Linguistic Inquiry*, 37(1), 111–130.

References

- Anagnostopoulou, E. (2003). *The syntax of ditransitives*. Berlin: Mouton de Gruyter.
- Anagnostopoulou, E., & Sevdali, C. (2015). Case alternations in Ancient Greek passives and the typology of Case. *Language*, 91(2), 442–481.
- Alsina, A., & Mchombo, S. (1990). The syntax of applicatives in Chicheŵa: Problems for a theta-theoretic asymmetry. *Natural Language and Linguistic Theory*, 8(4), 493–506.
- Anttila, A., Adams, M., & Speriosu, M. (2010). The role of prosody in the English dative construction. *Language and Cognitive Processes*, 25, 946–981.
- Bach, E. (1979). Control in Montague Grammar. *Linguistic Inquiry*, 10, 515–531.
- Baker, C. L. (1979). Syntactic theory and the projection problem. *Linguistic Inquiry*, 10, 533–581.
- Baker, M. C. (1988). *Incorporation: A theory of grammatical function changing*. Chicago: University of Chicago Press.
- Basilico, D. (2008). Particle verbs and benefactive double object constructions: High and low attachments. *Natural Language and Linguistic Theory*, 26, 731–773.
- Basilico, D. (2003). The topic of small clauses. *Linguistic Inquiry*, 34(1), 1–35.
- Barss, A., & Lasnik, H. (1986). A note on anaphora and double objects. *Linguistic Inquiry*, 17, 347–354.
- Beck, S., & Johnson, K. (2004). Double objects again. *Linguistic Inquiry*, 35, 97–124.
- Beavers, J. (2011). An aspectual analysis of verbs of caused possession in English. *Journal of Semantics*, 28, 1–54.

-
- Biggs, A. (2014). *Dissociating case from Theta-roles: A comparative investigation* (Unpublished PhD diss.). University of Cambridge, Cambridge, U.K.
- Bresnan, J. (1978). A realistic transformational grammar. In M. Halle, J. Bresnan, & G. A. Miller (Eds.), *Linguistic theory and psychological reality* (pp. 1–59). Cambridge, MA: MIT.
- Bresnan, J. (2007). Is syntactic knowledge probabilistic? Experiments with the English dative alternation. In S. Featherston & W. Sternfeld (Eds.), *Roots: Linguistics in search of its evidential base* (pp. 75–96). Berlin: Mouton de Gruyter.
- Bresnan, J., Cueni, A., Nikitina, T., & Baayen, R. H. (2007). Predicting the dative alternation <http://www.ehu.es/seg/_media/morf/5/5/6/sak/predicting_the_dative_alternation.pdf>. In G. Bouma, I. Kramer, & J. Zwarts (Eds.), *Cognitive foundations of interpretation* (pp. 69–94). Amsterdam: Royal Netherlands Academy of Arts and Sciences.
- Bruening, B. (2001). QR obeys superiority: Frozen scope and ACD. *Linguistic Inquiry*, 32, 233–274.
- Bruening, B. (2010a). Double object constructions disguised as prepositional datives. *Linguistic Inquiry*, 41.2, 287–305.
- Bruening, B. (2010b). Ditransitive asymmetries and a theory of idiom formation. *Linguistic Inquiry*, 41.3, 519–562.
- Chomsky, N. (1955). *The logical structure of linguistic theory*. Chicago: University of Chicago.
- Chomsky, N. (1970). Remarks on nominalization. In R. Jacobs & P. Rosenbaum (Eds.), *Readings in English transformational grammar*. Waltham, MA: Ginn and Company.
- Chomsky, N. (1981). *Lectures on government and binding*. Dordrecht: Foris.
- Chomsky, N. (1993). A minimalist program for linguistic theory. In K. Hale & S. J. Keyser (Eds.), *The view from Building 20* (pp. 1–52). Cambridge, MA: MIT Press.
- Chomsky, N. (1995). *The minimalist program*. Cambridge, MA: MIT Press.
- Collins, C., & Thráinsson, H. (1996). VP-internal structure and object shift in Icelandic. *Linguistic Inquiry*, 27(3), 391–444.
- Collins, C. (1997). *Local economy*. Cambridge, MA: MIT Press.
- Coppock, E. (2008). *The logical and empirical foundations of Baker's Paradox* (Unpublished PhD diss.). Stanford University, Stanford, CA.
- Cuervo, M. C. (2003). *Datives at large* (Unpublished PhD diss.). MIT, Cambridge, MA.
- Dikken, M. den. (1995). *Particles: On the syntax of verb-particle, triadic and causative constructions*. Oxford: Oxford University Press.
- Dikken, M. den. (2005). Review of Anagnostopoulou (2003). The syntax of ditransitives: Evidence from clitics. *Language*, 81(4), 980–984.

-
- Dowty, D. (1978). Governed transformations as lexical rules in a Montague Grammar. *Linguistic Inquiry*, 9, 393–426.
- Dowty, D. (1979). Dative ‘movement’ and Thomason’s extensions of Montague Grammar. In S. Davis, & M. Mithun (Eds.), *Linguistics, philosophy and Montague Grammar*. Austin: University of Texas Press.
- Emonds, J. (1972). Evidence that indirect object movement is a structure-preserving rule. *Foundations of Language*, 8, 546–561.
- Givón, T. (1984). Direct object and dative shifting: Semantic and pragmatic case. In F. Plank (Ed.), *Objects: Towards a theory of grammatical relations* (pp. 151–182). London: Academic Press.
- Green, G. (1974). *Semantics and syntactic regularity*. Bloomington: Indiana University Press.
- Grimshaw, J. (2005). Datives, feet and lexicons. In J. Grimshaw (Ed.), *Words and structure* (Chapter 4). Stanford, CA: Center for the Study of Language and Information Publications.
- Grimshaw, J., & Prince, A. (1986). *A prosodic account of the to-dative alternation* (Unpublished manuscript). Rutgers University.
- Gropen, J., Pinker, S., Hollander, M., Goldberg, R., & Wilson, R. (1989). The learnability and acquisition of the dative alternation in English. *Language*, 65, 203–257.
- Hallman, P. (2015). Syntactic neutralization in double object constructions. *Linguistic Inquiry*, 46(3), 389–424.
- Harada, S.-I. (1973). Counter equi-NP deletion. *Annual bulletin (Research Institute of Logopedics and Phoniatics, University of Tokyo)*, 7, 113–147.
- Harley, H. (1995). *Subjects, events, and licensing* (Unpublished PhD diss.). MIT, Cambridge, MA.
- Harley, H. (2002). Possession and the double object construction. *Linguistic variation yearbook*, 2, 29–68.
- Harley, H. (2008). The bipartite structure of verbs cross-linguistically, or, Why Mary can't exhibit John her paintings. In T. Cristófaró Silva & H. Mello (Eds.), *Conferências do V Congresso Internacional da Associação Brasileira de Lingüística* (pp. 45–84). Belo Horizonte, Brazil: ABRALIN and FALE/UFMG.
- Harley, H. (2009). *A morphosyntactic account of the ‘Latinize’ ban on dative shift in English*. Talk presented at UCSC, May 15, 2009.
- Harley, H., & Jung, H.-K. (2015). In support of the P_{HAVE} approach to the double object construction <http://dx.doi.org/10.1162/LING_a_00198>. *Linguistic Inquiry*, 46(4), 703–730. doi:10.1162/LING_a_00198
- Harley, H., & Noyer, R. (2000). Formal vs. encyclopedic properties of vocabulary: Evidence from nominalisations. In B. Peeters (Ed.), *The lexicon-encyclopedia interface* (pp. 349–374). Amsterdam: Elsevier.
- Haspelmath, M. (2015). Ditransitive constructions. *Annual Review of Linguistics*, 1, 19–41.
-

-
- Jacobson, P. (1983). *On the syntax and semantics of multiple relatives in English*. Bloomington: Indiana University Linguistics Club.
- Jacobson, P. (1987). Phrase structure, grammatical relations and discontinuous constituents. In G. Huck & A. Ojeda (Eds.), *Syntax and semantics 20: Discontinuous constituency*. New York: Academic Press.
- Jelinek, E. (1999). *Dative and argument hierarchies*. Paper presented at the 18th West Coast Conference on Formal Linguistics, University of Arizona.
- Jelinek, E., & Carnie, A. (2003). Argument hierarchies and the mapping principle. In A. Carnie, H. Harley, & M. Willie (Eds.), *Formal approaches to function in grammar* (pp. 265–296). Philadelphia: John Benjamins.
- Kageyama, T. (1993). *Bunpō-to gokeisei*. Tokyo: Hitsuji Shobō.
- Kayne, R. (1984). *Connectedness and binary branching*. Dordrecht: Foris.
- Kayne, R. (1993). Towards a modular theory of auxiliary selection. *Studia Linguistica*, 47, 3–31.
- Kim, L. (2015). Asymmetric ditransitive constructions: Evidence from Korean. *Lingua*, 165, 28–69.
- Kishimoto, H. (2001). The role of lexical meanings in argument encoding: Double object verbs in Japanese. *Gengo Kenkyu*, 120, 35–65.
- Kishimoto, H. (2006). Japanese syntactic nominalization and VP-internal syntax. *Lingua*, 116, 771–810.
- Koenig, J.-P., & Davis, A. R. (2001). Sublexical modality and the structure of lexical semantic representations. *Linguistics and Philosophy*, 24, 71–124.
- Krifka, M. (2001). *Lexical representation and the nature of the dative alternation* <<http://citeseerx.ist.psu.edu/viewdoc/download?doi=10.1.1.559.7970&rep=rep1&type=pdf>>. Talk presented at the DIP Colloquium, University of Amsterdam, November 11, 2001. doi: 10.1.1.559.7970&rep=rep1&type=pdf
- Kratzer, A. (2013). *Creating a family: Constructing transfer of possession verbs*. Paper presented at Little v Workshop, Leiden University, October 25–26.
- Larson, R. (1988). On the double object construction. *Linguistic Inquiry*, 19, 335–391.
- Levin, B. (1993). *English verb classes and alternations*. Chicago: University of Chicago.
- Levin, B. (2009). Dative verbs: A crosslinguistic perspective. *Linguisticæ Investigationes*, 31, 285–312.
- Levinson, L. (2004). *To in two places and the dative alternation* <<http://www.ling.upenn.edu/Events/PLC/plc28/handouts/levinson.pdf>>. Paper given at the Penn Linguistics Colloquium, February 28, 2004.
- Malchukov, A., Haspelmath, M., & Comrie, B. (Eds.). (2010). *Studies in ditransitive constructions: A comparative handbook*. Berlin: De Gruyter Mouton.
-

-
- Marantz, A. (1993). Implications of asymmetries in DOC. In S. Mchombo (Ed.), *Theoretical aspects of Bantu grammar* (pp. 113–150). Stanford, CA: CSLI.
- Marantz, A. (1997). No escape from syntax: Don't try morphological analysis in the privacy of your own lexicon <<http://repository.upenn.edu/pwpl/vol4/iss2/14>>. *University of Pennsylvania Working Papers in Linguistics*, 4(2), 201–225.
- McGinnis, M. (1998). *Locality in A-movement* (Unpublished PhD diss.). MIT, Cambridge, MA.
- Miyagawa, S. (1989). *Structure and case marking in Japanese*. *Syntax and semantics* 22. New York: Academic Press.
- Miyagawa, S., & Tsujioka, T. (2004). Argument structure and ditransitive verbs in Japanese. *Journal of East Asian Linguistics*, 13, 1–38.
- Miyagawa, S. (2012). *Argument structure, case, and word order*. Leading Linguists Series. New York: Routledge.
- Myers, S. (1984). Zero-derivation and inflection. In M. Speas & R. Sproat (Eds.), *Papers from the January 1984 MIT workshop in morphology* (pp. 53–69). MIT Working Papers in Linguistics 7. Cambridge, MA: Department of Linguistics and Philosophy, MIT.
- Oehrle, R. (1976). *The grammatical status of the English dative alternation* (Unpublished PhD diss.). MIT, Cambridge, MA.
- Ormazabal, J., & Romero, J. (2010). The derivation of dative alternations. In M. Duguine, S. Huidobro, & N. Madariaga (Eds.), *Argument structure and syntactic relations: A cross-linguistic perspective* (pp. 203–232). Amsterdam: John Benjamins.
- Pesetsky, D. (1995). *Zero syntax: Experiencers and cascades*. Cambridge, MA: MIT Press.
- Pinker, S. (1989). *Learnability and cognition: The acquisition of argument structure*. Cambridge, MA: MIT Press.
- Punske, J. (2013). Three forms of English verb particle constructions. *Lingua*, 135, 155–170.
- Pylkkänen, L. (2002). *Introducing arguments* (Unpublished PhD diss.). MIT, Cambridge, MA.
- Pylkkänen, L. (2008). *Introducing arguments*. Cambridge, MA: MIT Press.
- Rappaport-Hovav, M., & Levin, B. (2008). The English dative alternation: The case for verb sensitivity. *Journal of Linguistics*, 44, 129–167.
- Richards, N. (2001). An idiomatic argument for lexical decomposition. *Linguistic Inquiry*, 32, 183–192.
- Sadakane, K., & Koizumi, M. (1995). On the nature of the “dative” particle *ni* in Japanese. *Linguistics*, 33, 5–33.
- Shibatani, M. (1977). Grammatical relations and surface cases. *Language*, 53, 789–809.
- Shih, S. (2014). *Towards optimal rhythm* (Unpublished PhD diss.). Stanford University, Stanford, CA.

Snyder, K. (2003). *The relationship between form and function in ditransitive constructions* (Unpublished PhD diss.). University of Pennsylvania, Philadelphia.

Sugioka, Y. (1992). On the role of argument structure in nominalization. *Language, culture, and communication (Keio University)*, 10, 53-80.

Wood, J., & Marantz, A. (2015). *The interpretation of external arguments* <<http://psych.nyu.edu/morphlab/publications/Wood%20&%20Marantz%202015.pdf>> (Unpublished manuscript). New York University.

Woolford, E. (2006). Lexical case, inherent case, and argument structure. *Linguistic Inquiry*, 37(1), 111-130.

Related Articles

Locality in Syntax

Korean Syntax

Scrambling in Korean Syntax