

Timing and distribution of protein ingestion during prolonged recovery from resistance exercise alters myofibrillar protein synthesis

José L. Areta¹, Louise M. Burke², Megan L. Ross², Donny M. Camera¹, Daniel W. D. West³, Elizabeth M. Broad², Nikki A. Jeacocke², Daniel R. Moore⁴, Trent Stellingwerff⁴, Stuart M. Phillips³, John A. Hawley¹ and Vernon G. Coffey¹

¹Exercise Metabolism Group, Health Innovations Research Institute, School of Medical Sciences, RMIT University, Melbourne, Australia

²Sports Nutrition, Australian Institute of Sport, Canberra, ACT, Australia

³Exercise Metabolism Research Group, Department of Kinesiology, McMaster University, Hamilton, Ontario, Canada

⁴Nestlé Research Center, Lausanne, Switzerland

Key points

- A single bolus of ~20 g of protein after a bout of resistance exercise provides a maximal anabolic stimulus during the early post-exercise recovery period (~5 h), but the effect of various protein feeding strategies on skeletal muscle protein synthesis during an extended recovery period (12 h) is unknown.
- We compared three different patterns of ingestion of 80 g of protein during 12 h recovery after resistance exercise and the associated anabolic response in human skeletal muscle. Protein was ingested in 10, 20 or 40 g feedings using a pulsed, intermediate or bolus ingestion regimen, respectively.
- Our results indicate that repeated ingestion of 20 g of protein was superior for stimulating muscle protein synthesis during the 12 h experimental period.
- The three dietary treatments induced differential phosphorylation of signalling proteins and changes in mRNA abundance.
- This study shows that the distribution of protein intake is an important variable to promote attainment and maintenance of peak muscle mass.

Abstract Quantity and timing of protein ingestion are major factors regulating myofibrillar protein synthesis (MPS). However, the effect of specific ingestion patterns on MPS throughout a 12 h period is unknown. We determined how different distributions of protein feeding during 12 h recovery after resistance exercise affects anabolic responses in skeletal muscle. Twenty-four healthy trained males were assigned to three groups ($n = 8/\text{group}$) and undertook a bout of resistance exercise followed by ingestion of 80 g of whey protein throughout 12 h recovery in one of the following protocols: 8×10 g every 1.5 h (PULSE); 4×20 g every 3 h (intermediate: INT); or 2×40 g every 6 h (BOLUS). Muscle biopsies were obtained at rest and after 1, 4, 6, 7 and 12 h post exercise. Resting and post-exercise MPS ($L\text{-}[ring\text{-}^{13}\text{C}_6]$ phenylalanine), and muscle mRNA abundance and cell signalling were assessed. All ingestion protocols increased MPS above rest throughout 1–12 h recovery (88–148%, $P < 0.02$), but INT elicited greater MPS than PULSE and BOLUS (31–48%, $P < 0.02$). In general signalling showed a BOLUS > INT > PULSE hierarchy in magnitude of phosphorylation. MuRF-1 and SLC38A2 mRNA were differentially expressed with BOLUS. In conclusion, 20 g of whey protein consumed every 3 h was superior to either PULSE

or BOLUS feeding patterns for stimulating MPS throughout the day. This study provides novel information on the effect of modulating the distribution of protein intake on anabolic responses in skeletal muscle and has the potential to maximize outcomes of resistance training for attaining peak muscle mass.

(Received 12 September 2012; accepted after revision 25 February 2013; first published online 4 March 2013)

Corresponding author J. A. Hawley: School of Medical Sciences, RMIT University, Bundoora, Victoria 3083, Australia.

Email: john.hawley@rmit.edu.au

Abbreviations: AA, amino acid; BCAA, branched chain amino acid; EAA, essential amino acid; FSR, fractional synthetic rate; MPS, myofibrillar protein synthesis; mTOR, mammalian target of rapamycin; RM, repetition maximum; rpS6, ribosomal protein S6; TSC2, tuberlin sclerosis complex-2.

Introduction

Skeletal muscle protein synthesis is stimulated by exercise (Chesley *et al.* 1992; Biolo *et al.* 1995; Phillips *et al.* 1997) and protein feeding (Rennie *et al.* 1982; Cuthbertson *et al.* 2005). When feeding follows exercise the effect is enhanced (Moore *et al.* 2009*a,b*) and promotes positive net protein balance in skeletal muscle (Phillips *et al.* 1997). Although the majority of studies of exercise and protein ingestion have characterized the response to a single protein feeding over 4–6 h of recovery (Tipton *et al.* 1999; Dreyer *et al.* 2008; Moore *et al.* 2009*a,b*; West *et al.* 2011), it is important to note that the enhanced sensitivity of myofibrillar protein synthesis (MPS) to protein ingestion following resistance exercise is sustained for at least 24 h (Burd *et al.* 2011). However, the paucity of studies measuring MPS beyond the traditional 4–6 h recovery window precludes our ability to prescribe an optimized spacing and amount of protein intake throughout the day or during a prolonged (i.e. 12 h) recovery period after resistance exercise. Such information could be important for enhancing skeletal muscle mass with the potential for use in a variety of populations including the elderly and athletes (Layman, 2009; Paddon-Jones & Rasmussen, 2009; Phillips & Van Loon, 2011).

Investigations during early recovery after exercise provide some insight into the potentially beneficial effects of longer term feeding strategies. It is known that there is a dose–response in muscle protein synthesis to the intensity (Kumar *et al.* 2009) and volume (Burd *et al.* 2010) of exercise, as well as to the amount of protein consumed after exercise (Moore *et al.* 2009*a*). Specifically, muscle protein synthesis can be maximally stimulated by the intake of 20 g of high quality protein (Moore *et al.* 2009*a*), with lower doses resulting in suboptimal rates of muscle protein synthesis, and protein intakes above this level stimulating irreversible oxidative amino acid (AA) catabolism (Moore *et al.* 2009*a*). Furthermore, rates of MPS 1–5 h after a bout of resistance exercise are higher when rapid aminoacidaemia is achieved by ingesting a bolus (25 g) of whey protein compared to a slow, moderate but sustained

rise in blood amino acids elicited by an identical protein source consumed in a pulsed feeding pattern (West *et al.* 2011). Thus, the interplay of the quantity and timing of protein ingestion is a major factor regulating the capacity of the muscle protein synthetic machinery to respond to repeated anabolic stimuli. Importantly, elevated rates of muscle protein synthesis return to basal values in the resting state after 2 h of AA provision (either orally or intravenously) despite a sustained AA availability (Bohe *et al.* 2001; Atherton *et al.* 2010), a phenomenon called the ‘muscle full’ effect (Atherton *et al.* 2010). How rapidly the protein synthesis machinery recapitulates its capacity to respond to the provision of nutrients and whether there are differences in the optimal timing and quantities of protein necessary to repeatedly stimulate maximal skeletal muscle protein synthesis after a bout of resistance exercise have not been determined. There may also be potential for exceptions to the ‘muscle full’ effect under specific physiological or experimental conditions (Glover *et al.* 2008). Another important factor to consider is the capacity of exercise to extend the duration of the anabolic stimulus induced by feeding (Moore *et al.* 2009*b*). Collectively, this suggests that increased aminoacidaemia after exercise is beneficial for the muscle hypertrophy response but the optimal pattern of aminoacidaemia remains to be established.

Therefore, the aim of the present study was to determine how the quantity and timing of protein ingestion after a single bout of resistance exercise influence the muscle anabolic response throughout the entire day. Previous studies have shown muscle protein synthesis following increased availability of amino acids peaks within ~2 h (Bohe *et al.* 2001; Atherton *et al.* 2010) but cyclical oscillation of aminoacidaemia appears to be required to prevent a potential ‘muscle full’ effect (Atherton *et al.* 2010). Therefore, in the present study we hypothesized that 20 g of protein ingested every 3 h would be the optimal intervention for repeated stimulation of MPS due to provision of sufficient (Moore *et al.* 2009*a*), but not excessive, protein to stimulate MPS.

Table 1. Subjects' characteristics

	Group		
	Bolus	Intermediate	Pulse
<i>n</i>	8	7	8
Age (years)	25 ± 5	25 ± 3	25 ± 5
Body mass (kg)	83.6 ± 10.5	80.5 ± 11.1	82.0 ± 6.4
Percentage fat	16.7 ± 5.2	14.6 ± 6.9	15.1 ± 5.8
Lean body mass (kg)	66.2 ± 5.4	65.3 ± 6.4	66.5 ± 5.3
1 RM (kg)	125 ± 9	128 ± 21	137 ± 18
1 RM/body mass (kg)	1.51 ± 0.18	1.59 ± 0.16	1.68 ± 0.21

Data are mean ± SD. RM, repetition maximum.

Methods

Ethical approval

Subjects were informed of any potential risks involved in the study before providing their written informed consent. The study was approved by the Australian Institute of Sport Ethics Committee and conformed to the standards set by the latest revision of the *Declaration of Helsinki*.

Subjects

Twenty-four young, healthy non-smoking males with at least 2 years of high-intensity resistance training experience (≥ 2 times per week) were recruited for this study (Table 1). Technical error (i.e. incorrect protein administration) necessitated that one subject was excluded from the final analysis. Body composition was measured using a whole-body scan narrowed fan-beam dual energy X-ray analysis (DXA Lunar Prodigy, GE Healthcare, Madison, WI, USA) with GE Encore 13.60 software (GE Healthcare). Anthropometric measurements and one repetition maximum (RM) were assessed 1–2 weeks before experimental trials.

Diet and exercise control

Subjects were each provided with individualized pre-packed meals for the 72 h prior to an experimental trial. The standardized diets were based on achieving daily energy availability (intake minus energy cost of exercise) of 45 kcal (kg fat-free mass)⁻¹, and provided a daily intake of 1.5 g protein (kg body mass)⁻¹ and 4 g CHO (kg body mass)⁻¹ with the remaining energy coming from fat. No exercise was allowed during the 48 h period prior to a trial, but subjects were allowed to undertake their habitual training session during the first day of the dietary standardization, with an appropriate snack being provided in their prepackaged meals to account for the energy cost of the session. Subjects were instructed to refrain from any

alcohol or caffeine consumption 48 h prior to a trial and to consume the last meal of their diets prior to 21.00 h the night before a trial. A food and exercise checklist was completed by each subject to note the compliance to these instructions.

Experimental trials

Subjects were matched for body mass before being randomly assigned to one of three different experimental groups using a parallel group design. An overview of the experimental procedure is shown in Fig. 1. Subjects reported to the laboratory at ~07.00 h after a 10–12 h overnight fast and a Teflon catheter was inserted in the antecubital vein of each arm for blood sampling and tracer infusion. A primed, continuous (0.05 $\mu\text{mol}\cdot\text{kg}^{-1}\cdot\text{min}^{-1}$; 2 $\mu\text{mol}\cdot\text{kg}^{-1}$ prime) infusion of L-[ring-¹³C₆] phenylalanine (Cambridge Isotopes Laboratories, Woburn, MA, USA) commenced immediately after the first (baseline) blood sample was drawn. After a resting period of 2 h, the first muscle biopsy was taken and subjects undertook the resistance exercise bout (described subsequently). After exercise and during the following 12 h recovery period, subjects consumed 80 g of a commercially available whey protein isolate (ISO8 WPI; 82.9 g protein, 2.1 g fat, 3.4 g carbohydrates per 100 g; Musashi, Australia), enriched with 5% L-[ring-¹³C₆] phenylalanine, and mixed with water to a total volume of one litre. Drinks were consumed within the 12 h period after the resistance exercise bout according to the following schedule: pulsed feeding consisting of 8 × 10 g in 125 ml every 1.5 h (PULSE, *n* = 8); intermediate feeding consisting of 4 × 20 g in 250 ml every 3 h (INT, *n* = 7); or bolus feeding consisting of 2 × 40 g in 500 ml every 6 h (BOLUS, *n* = 8). Water was provided *ad libitum* with 30 min restrictions before and after each protein drink to avoid any potential influence on gastric emptying.

Biological samples

Blood samples (4 ml) were taken before the exercise bout and at repeated time points throughout recovery (Fig. 1). Muscle biopsy samples were taken from the vastus lateralis using 5 mm Bergström needles adapted for manual suction immediately before exercise and at 1, 4, 6, 7 and 12 h post exercise. The initial three biopsies were taken from a randomly selected leg and the final three biopsies were taken from the contralateral leg. Distance between sampling points was ~0.5 cm and biopsies were taken from distal to proximal. Muscle was cleaned with saline to remove excess blood and immediately frozen in liquid N₂. Muscle and plasma samples were stored at -80°C until subsequent analysis.

Exercise

Bilateral leg extension 1 RM strength test was completed by each subject a minimum of 1 week prior to the experimental protocol using a plate-loaded machine. After a warm-up of two sets of five moderate intensity repetitions the 1 RM was determined as the highest successfully lifted weight during a maximum of six attempts. On the day of a trial subjects completed two warm-up sets of five repetitions at ~50 and ~60% 1 RM with 2 min rest between sets. The resistance exercise training bout incorporated four sets of 10 repetitions at ~80% 1 RM with 3 min rest between sets. Exercise range of motion was ~85 deg, with leg extension endpoint set at ~5 deg from full extension.

Analytical procedures

Insulin and amino acid concentration. Plasma insulin concentration was measured using an automated enzyme amplified chemiluminescence Immulite 1000 system (Siemens Diagnostics, Australia) according to the manufacturer's guidelines. Plasma amino acids were analysed by high performance liquid chromatography to determine amino acid concentrations as described previously (Wilkinson *et al.* 2007; West *et al.* 2011). Estimates of the precision of the method were determined by assessing the repeatability of standards (1.5, 2.5, 3.5, 5, 10 μ l) injected to generate a standard curve. Coefficients of variation for the volumes listed above were 5–15%.

Western blot. Intracellular signalling proteins were extracted, isolated and quantified as previously described (Coffey *et al.* 2011). The amount of

protein loaded in each well was 50 μ g. Polyclonal anti-phospho mammalian target of rapamycin (mTOR) Ser2448 (no. 2971), monoclonal anti-phospho-Akt Ser473 (no. 9271), tuberlin sclerosis complex-2 (TSC2) Thr1462 (no. 3617), ribosomal protein S6 (rpS6) Ser235/6 (no. 4856), 4E-BP1 Thr37/46 (no. 2855), eEF2 Thr56 (no. 2331), and anti- α -tubulin control protein (no. 3873) were purchased from Cell Signaling Technology (Danvers, MA, USA). Polyclonal anti-phospho-PRAS40 Thr246 (no. 07–888), p70 S6K Thr389 (no. PK1015) were from Millipore (Temecula, CA, USA).

Fractional synthetic rate. Pre-infusion plasma sample proteins as first measurement time point (Burd *et al.* 2012b) were extracted in acetonitrile. Muscle tissue was processed as previously described (Moore *et al.* 2009b).

Calculations. The fractional synthetic rate (FSR; % h^{-1}) of myofibrillar proteins was calculated using the standard precursor–product method:

$$FSR = (E_{p2} - E_{p1}) / E_{ic} \times 1/t \times 100$$

where $E_{p2} - E_{p1}$ represents the change in bound protein enrichment between two biopsy samples; E_{ic} is the average enrichment of intracellular phenylalanine between the two biopsy samples; and t is the time between biopsies. The utilization of 'tracer-naive' subjects allowed us to use the pre-infusion blood sample (i.e. mixed plasma protein fraction) as the baseline enrichment (E_{p1}) for the calculation of resting MPS (Burd *et al.* 2010). All measurements of enrichment, whether made using gas chromatography–mass spectrometry (GC-MS) or gas chromatography combustion isotope ratio mass

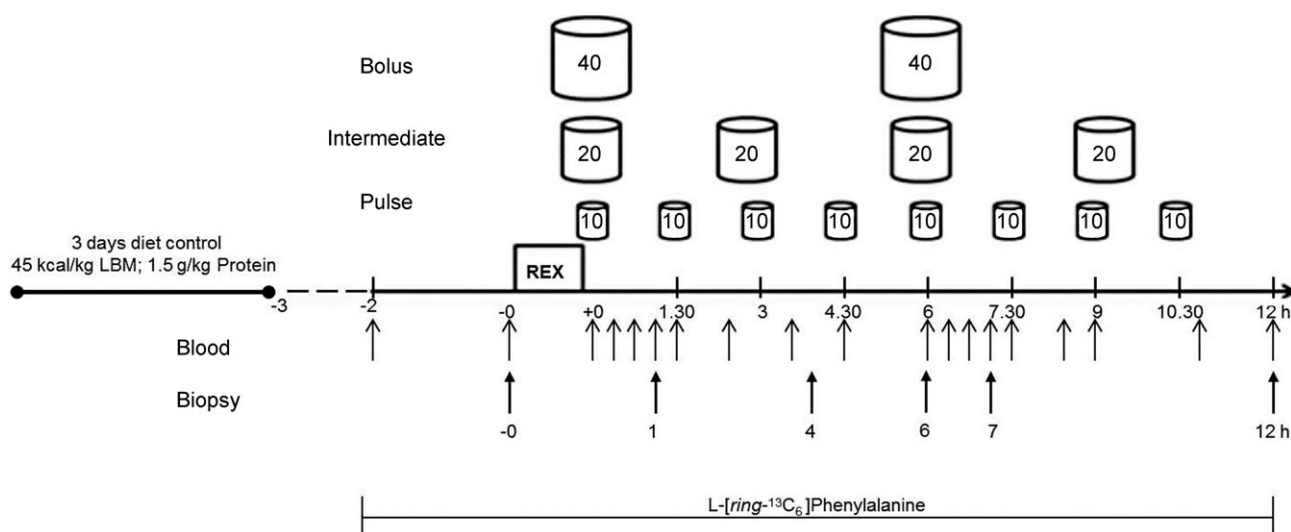

Figure 1

Schematic representation of the experimental protocol. Negative time points indicate before exercise, positive time points indicate after exercise. LBM, lean body mass; REX, resistance exercise.

spectrometry (GC-C-IRMS) were validated using external standard curves with standards of known composition. Plasma-free, muscle intracellular, and protein-bound enrichments fell within the linear range and coefficients of variability on repeat measurements never exceeded 5–6%.

RNA extraction, reverse transcription and RT-PCR.

Skeletal muscle (~20 mg) tissue RNA extraction, reverse transcription and real-time polymerase chain reaction (RT-PCR) was performed as previously described (Camera *et al.* 2012; West *et al.* 2012). TaqMan-FAM-labelled primer/probes for atrogen-1 (Hs01041408_m1), MuRF-1 (Hs00822397_m1), SLC3A8 (Hs00255854_m1) and BCAT2 (Hs01553550_m1) primers (Applied Biosystems, Carlsbad, CA, USA) were used. Glyceraldehyde-3-phosphate dehydrogenase (GAPDH, HS9999-9905_m1) was used as the housekeeping gene. The relative amounts of mRNAs were calculated using the relative quantification ($\Delta\Delta CT$) method (Livak & Schmittgen, 2001). Analysis of mRNA was restricted to 1 h, 7 h and 12 h post exercise due to limited muscle sample at various time points.

Statistical analysis. Data were analysed using two-way analysis of variance (ANOVA) with Student–Newman–Keuls *post hoc* analysis (SigmaStat for Windows; Version 3.10). Data for western blotting were log-transformed prior to analysis. All data are presented as mean \pm standard deviation (SD) and the level of statistical significance was set at $P < 0.05$.

Results

Plasma insulin concentration

There was a time \times group interaction for plasma insulin concentration ($P < 0.001$). Plasma insulin concentration was increased above resting levels only in BOLUS, peaking 40 min after exercise (Fig. 2). Plasma insulin concentration

in BOLUS was also increased above rest at 20 min, 40 min, 1 h, 1 h 30 min, (~3- to 8-fold $P < 0.05$) and 6 h 40 min, 7 h and 7 h 30 min (~2- to 4-fold; $P < 0.05$) post exercise after the first and second drink respectively. BOLUS was greater than INT and PULSE conditions at the corresponding time points (~2- to 4-fold; $P < 0.05$).

Plasma amino acids

There was a time \times group interaction ($P < 0.001$) for plasma EAA, BCAA and leucine concentrations. There were robust increases in AA concentration during the early (1–6 h) recovery period following BOLUS compared to more moderate changes for INT and PULSE (Fig. 3). EAA concentration increased above resting levels after feeding in BOLUS peaking 40 min post exercise (135%; $P < 0.001$). BCAA and leucine concentrations were different from rest 40 min after ingestion of BOLUS (37 and 57%, respectively; $P < 0.05$) and remained elevated 3.5 h post exercise. After the initial INT feeding there was a trend towards difference from rest for leucine ($P = 0.06$) but not for BCAA or EAA. Changes in AA concentration with PULSE did not increase above resting values during the 1–6 h recovery period.

During the late recovery period (6–12 h) the different AA sub-fractions increased above resting levels in response to all feeding protocols. However, peak EAA, BCAA and leucine concentrations were higher for BOLUS (87–205%; $P < 0.001$) compared with INT (110–39%; $P < 0.04$) and PULSE (67–174%; $P < 0.004$). Notably, PULSE sustained the increase in AA concentration above resting values throughout the 6–12 h recovery period (64–83%; $P < 0.03$) and remained above resting values at 12 h (42–83%; $P < 0.005$). The concentration of each AA sub-fraction with BOLUS remained elevated at 9 h (52–87%; $P < 0.001$) and BOLUS and INT returned to resting values at 12 h and were lower compared to PULSE at the end of recovery for EAA (19–50%; $P < 0.05$). The increase in AA concentration with INT was restricted to the 6–7 h period (i.e. 6 h 40 min) and was lower in INT

Figure 2

Plasma insulin concentration following a bout of leg extension resistance exercise (4 sets \times 10 repetitions at 80% one repetition maximum) and post-exercise ingestion of 80 g whey protein consumed using a BOLUS (2 \times 40 g every 6 h), INT (4 \times 20 g every 3 h) or PULSE (8 \times 10 g every 1.5 h) ingestion protocol during a 12 h recovery period. –0 and +0 h are pre- and post exercise, respectively. Data were analysed using a 2-way ANOVA with Student–Newman–Keuls *post hoc* analysis. Values are mean \pm SD. Different vs. §, all other time points within treatment; a, rest; †, Intermediate and *, Pulse, at equivalent time point ($P < 0.05$).

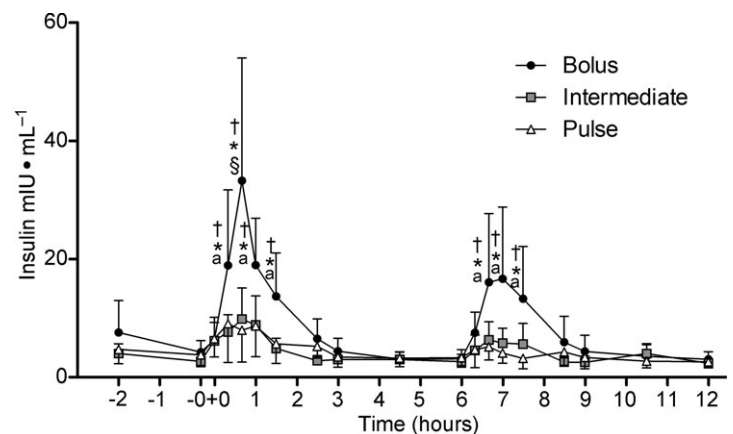

than PULSE and BOLUS at the equivalent time point (21–41%; $P < 0.04$).

Intracellular and plasma tracer enrichments

Intracellular free phenylalanine enrichments showed a stable precursor pool throughout the 14 h infusion in all groups (Supplemental Fig. 1a, available online only).

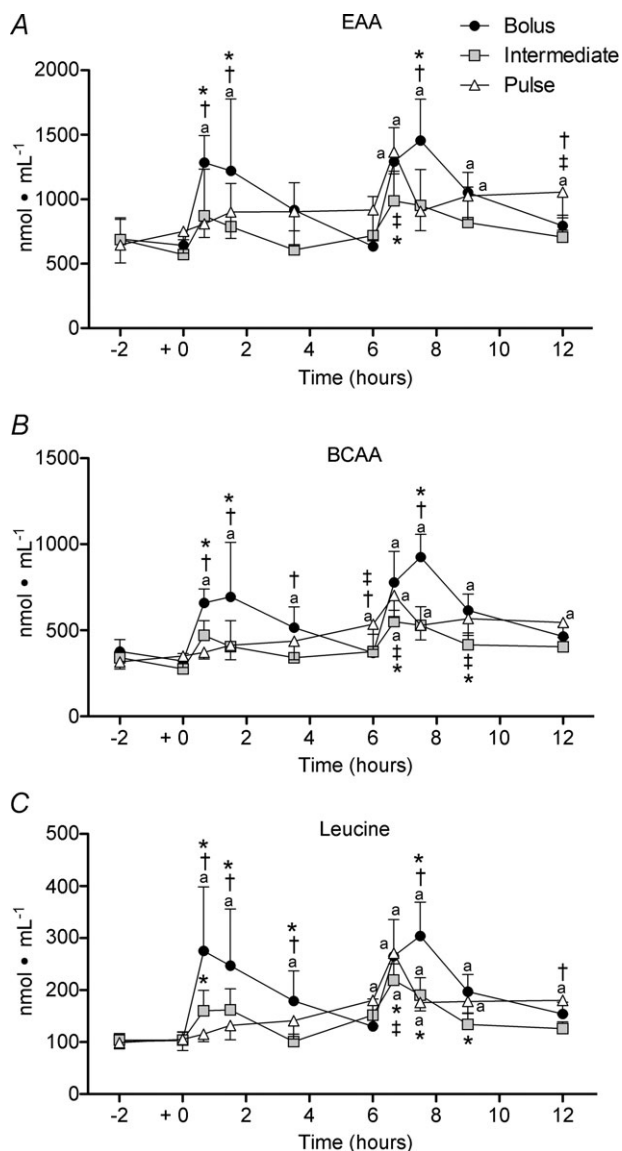

Figure 3

Plasma essential amino acids (EAA; A), branched-chain amino acids (BCAA; B), and leucine (C) concentration following a bout of leg extension resistance exercise and post-exercise BOLUS, INT or PULSE ingestion protocol during a 12 h recovery period, as described in Fig. 2. Data were analysed using a 2-way ANOVA with Student–Newman–Keuls *post hoc* analysis. Values are mean \pm SD. Different vs. a, rest; *, Pulse; †, Intermediate; and ‡, Bolus, at equivalent time point ($P < 0.05$).

Linear regression line slopes of plasma enrichments were not significantly different from zero in BOLUS, INT and PULSE groups ($P = 0.96, 0.98, 0.99$, respectively; Supplemental Fig. 1b).

Myofibrillar fractional synthetic rate

Each ingestion protocol resulted in increased myofibrillar FSR above resting values throughout 1–12 h of recovery (88–148%; $P < 0.02$; Fig. 4B) with values of 0.06, 0.079 and 0.053% · h⁻¹ for PULSE, INT and BOLUS, respectively.

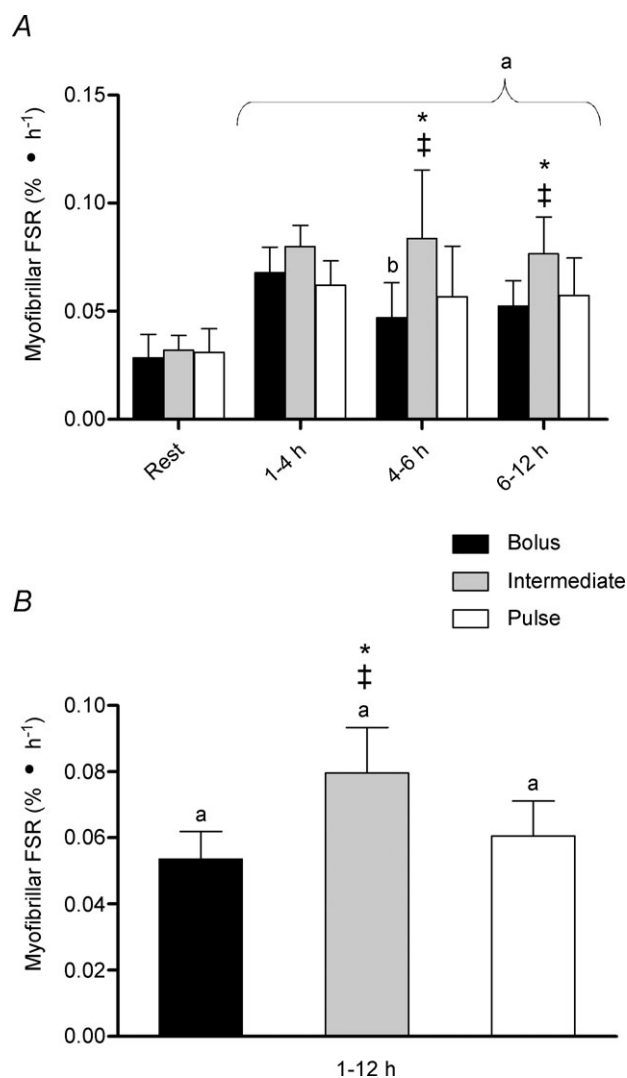

Figure 4

Myofibrillar fractional synthetic rate (FSR) between time points (A) and mean FSR throughout 1–12 h (B) following a bout of leg extension resistance exercise and post-exercise BOLUS, INT or PULSE ingestion protocol during a 12 h recovery period, as described in Fig. 2. Data were analysed using a 2-way ANOVA with Student–Newman–Keuls *post hoc* analysis. Values are mean \pm SD expressed as % · h⁻¹. Different vs. a, Rest; b, 1–4 h; †, Bolus and *, Pulse at equivalent time point ($P < 0.05$).

There were corresponding increases in FSR during the early 1–4 h recovery period regardless of timing or quantity of protein ingestion (Fig. 4A). Thereafter, INT generated a superior FSR compared to PULSE and BOLUS during the 4–6 and 6–12 h periods (47–78% and 34–42%, respectively; $P < 0.02$). Consequently, INT elicited a greater rate of myofibrillar FSR during the entire 1–12 h period compared to both PULSE and BOLUS (31 and 48% difference, respectively; $P < 0.02$).

Signalling responses

Akt/TSC2. Akt^{Ser473} phosphorylation during recovery from exercise increased above rest in BOLUS at 1 h (~4-fold) and was higher than all other time points ($P < 0.05$; Fig. 5A). Phosphorylation of Akt at 1 h was also greater in BOLUS compared to INT and PULSE (~2-fold difference; $P < 0.03$) whereas at 7 h it was higher in both

BOLUS and INT compared to PULSE (~3- and ~2-fold difference, respectively; $P < 0.02$). Similar to Akt^{Ser473} the phosphorylation of TSC2^{Thr1462} increased above resting values only in BOLUS at 1 and 7 h (~4- and 3-fold, respectively; $P < 0.002$; Fig. 5B). At the 4 h time point until the end of the recovery (12 h) TSC2 phosphorylation in INT was generally lower than BOLUS and PULSE (~3- to 2-fold; $P < 0.05$).

mTOR/PRAS40. The protein ingestion protocols generated similar increases in phosphorylation of mTOR^{Ser2448} throughout 12 h recovery (Fig. 5C). Generally, all time points for each group were higher than rest (~2- to ~6-fold, $P < 0.05$). Peak mTOR phosphorylation occurred in BOLUS at 1 and 7 h post exercise (~6- and ~5-fold, respectively) but was not different from INT or PULSE at the equivalent time point. There was a significant increase in PRAS40^{Thr246}

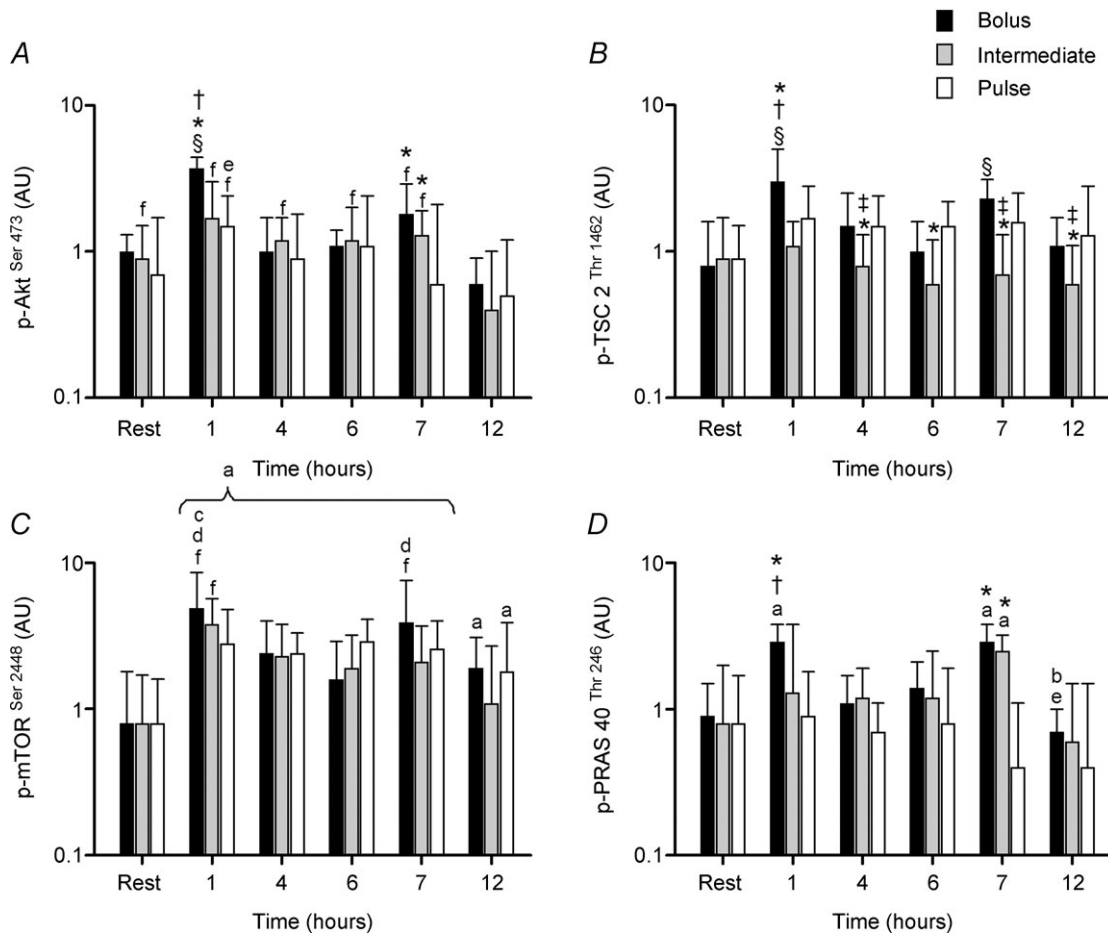

Figure 5 Phosphorylation of Akt^{Ser473} (A), TSC2^{Thr1462} (B), mTOR^{Ser2448} (C), PRAS40^{Thr246} (D), following a bout of leg extension resistance exercise and post-exercise BOLUS, INT or PULSE ingestion protocol during a 12 h recovery period, as described in Fig. 2. Data were analysed using a 2-way ANOVA with Student–Newman–Keuls *post hoc* analysis. Values are mean ± SD expressed as arbitrary units. Different vs. §, all time points within treatment; a, rest; b, 1 h post exercise; c, 4 h post exercise; d, 6 h post exercise; e, 7 h post exercise; f, 12 h post exercise; *, Pulse; †, Intermediate; and ‡, Bolus at equivalent time point ($P < 0.05$).

phosphorylation above resting values in BOLUS at 1 and 7 h (~ 3 -fold; $P < 0.05$) and INT at 7 h (~ 3 -fold; $P < 0.05$) after cessation of exercise but the phosphorylation state of PRAS40^{Thr246} was unchanged with PULSE (Fig. 5D). Phosphorylation of PRAS40^{Thr246} after 1 h of recovery was higher in BOLUS compared with INT and PULSE (~ 2 - and ~ 3 -fold, respectively, $P < 0.05$) whereas at 7 h both BOLUS and INT were different from PULSE (~ 7 - and ~ 6 -fold, respectively, $P < 0.001$).

p70 S6K/rpS6. p70 S6K^{Thr389} phosphorylation was elevated above resting values during the 12 h of recovery for all ingestion protocols (~ 3 - to ~ 26 -fold; $P < 0.02$) but with different magnitudes in the response between interventions (Fig. 6A). BOLUS elicited the highest phosphorylation at 1 h (~ 26 -fold; $P < 0.001$) with a second lower peak at 7 h (12-fold; $P < 0.001$). Phosphorylation in INT peaked at 1 h (12-fold; $P < 0.001$) and 4 h (7-fold; $P < 0.001$) but was similar throughout the remainder of the recovery period. Phosphorylation

of p70 S6K above rest in PULSE showed little variation between time points (3- to 6-fold). The p70 S6K^{Thr389} phosphorylation response at 1 h was higher in BOLUS and INT compared to PULSE (~ 5 - and ~ 2 -fold, respectively; $P < 0.02$) and at 7 h was higher in BOLUS than INT and PULSE (~ 2 - and ~ 3 -fold, respectively; $P < 0.02$).

rpS6^{Ser235/236} phosphorylation was only higher than resting levels during recovery in BOLUS at 1 and 7 h post exercise (12- and ~ 6 -fold, respectively; $P < 0.01$; Fig. 6B). Phosphorylation at the 1 h time point was higher in BOLUS compared to PULSE (~ 5 -fold; $P < 0.03$), and at 7 h phosphorylation was higher in BOLUS than both INT and PULSE (~ 3 - and ~ 7 -fold, respectively; $P < 0.05$).

mRNA responses

The mRNA abundance of MuRF-1 increased at 1 h post exercise compared to all other time points in INT and PULSE (2- to 3-fold compared to rest; $P < 0.001$) but MuRF-1 mRNA did not change during the recovery period in BOLUS. Consequently, MuRF-1 expression was higher

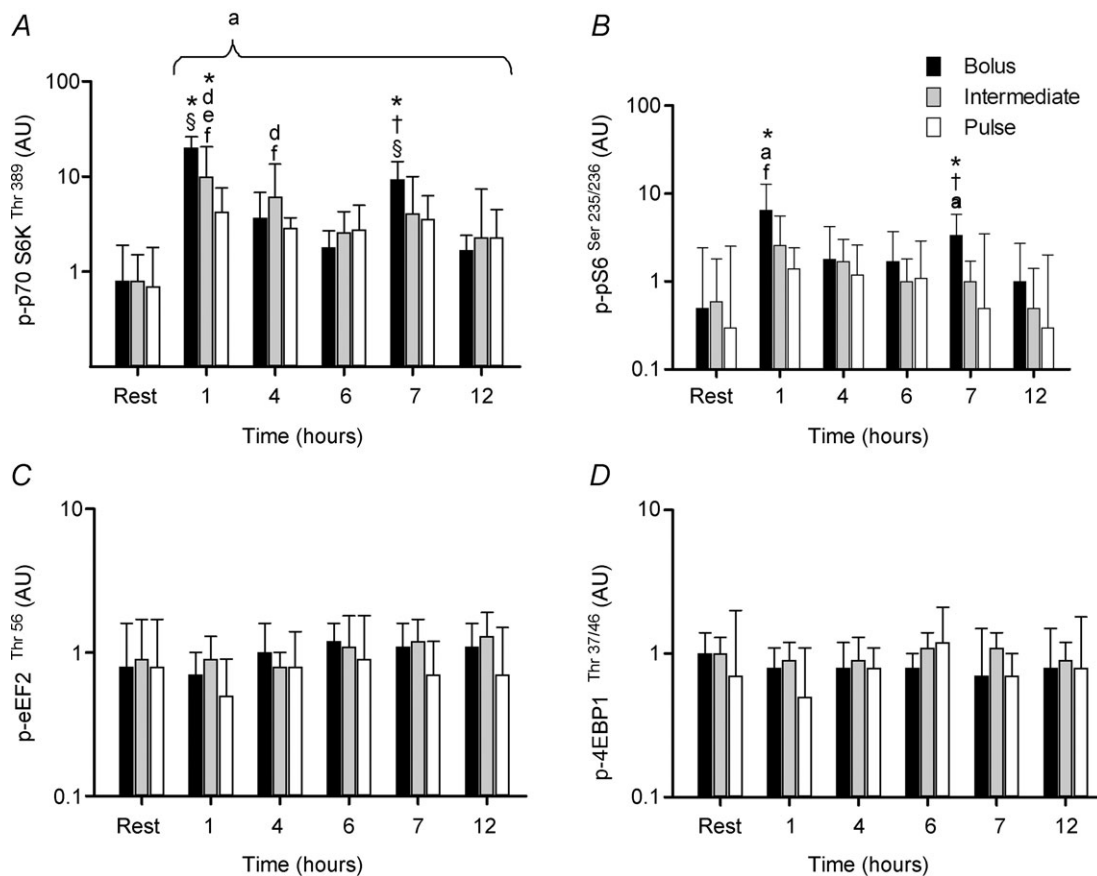

Figure 6

Phosphorylation of p70 S6K^{Thr389} (A), rpS6^{Ser235/236} (B), eEF2^{Thr56} (C) and 4E-BP1^{Thr37/46} (D) following a bout of leg extension resistance exercise and post-exercise BOLUS, INT or PULSE ingestion protocol during a 12 h recovery period, as described in Fig. 2. Data were analysed using a 2-way ANOVA with Student–Newman–Keuls *post hoc* analysis. Values are mean \pm SD expressed as arbitrary units. Different vs. §, all time points within treatment; a, rest; d, 6 h post exercise; f, 12 h post exercise; *, Pulse; and †, Intermediate; at equivalent time point ($P < 0.05$).

in INT and PULSE compared to BOLUS at 1 h ($P < 0.001$; Fig. 7A). There were no differences in the abundance of atrogen-1 mRNA within or between groups during the entire recovery period (data not shown).

SLC38A2 (SNAT2) mRNA expression was increased at 1 h post exercise compared to all other time points within BOLUS (~2-fold compared to rest; $P < 0.05$), but there was no change after either INT or PULSE protocols (Fig. 7B). There were no changes in mRNA expression of BCAT2 during the recovery period (data not shown).

Discussion

This study provides novel information demonstrating that the regulation of muscle protein synthesis can be substantially modulated by the timing and distribution of 80 g of protein intake during prolonged (12 h) recovery from a single bout of resistance exercise. Specifically, we show for the first time that rates of myofibrillar protein synthesis (MPS) remain elevated above rest throughout 12 h of recovery when a single bout of resistance exercise is followed by the partitioned ingestion of 80 g of high quality protein. Furthermore, we show that daily rates of protein synthesis were highest with regular (i.e. every 3 h) intake of a moderate (20 g) quantity of rapidly digested whey protein. We also show that the nutrient- and contraction-sensitive intracellular signalling network regulating translation for protein synthesis was stimulated in response to all feeding protocols but in a hierarchical manner where BOLUS was higher than INT and PULSE.

Previous studies examining the effects of protein availability on mixed muscle protein synthesis at rest have shown that despite prolonged hyperaminoacidaemia, rates of muscle protein synthesis return to resting levels within 2 h after peak aminoacidaemia (Bohe *et al.* 2001;

Atherton *et al.* 2010). As might be expected, the provision of exogenous protein post exercise elevated MPS above basal levels regardless of the feeding pattern. While the INT bound incorporation values appear systematically lower they are, in fact, not statistically different and even when using a mean intracellular enrichment from the other groups the differences in FSR persist. Therefore, intracellular enrichments over the 12 h feeding period are not the reason for the higher FSR values in INT. Consequently, the superior MPS in INT was possibly due to an optimized interplay between resistance exercise, time between ingestion, and quantity of each (whey) protein feeding; this probably resulted in a cyclical plasma AA profile that might be considered ideal to stimulate MPS. We have previously reported that there appears to be a minimum threshold for elevation of blood aminoacidaemia to generate maximal rates of muscle protein synthesis and that a sufficient quantity of rapidly digested protein is required to transiently induce an optimal protein synthesis response (Moore *et al.* 2009a; West *et al.* 2011). While the temporal resolution of time points selected for quantifying plasma amino acid concentrations failed to clearly show distinct amino acid profiles throughout the 12 h post-exercise period a hierarchical response was observed for leucine concentration early in recovery indicative of an initial divergence in branch-chain amino acid availability between feeding patterns (Fig. 3). Thereafter, the continuous hyperaminoacidaemia or lack of post-prandial periods of relative hypoaminoacidaemia over the 12 h period with PULSE feeding most likely resulted in some suboptimal stimulation of the protein synthesis machinery similar to that observed with continuous amino acid infusion. In contrast, larger boluses of protein (i.e. >20 g) are sufficient to maximally stimulate muscle protein synthesis, but represent a suboptimal ingestion

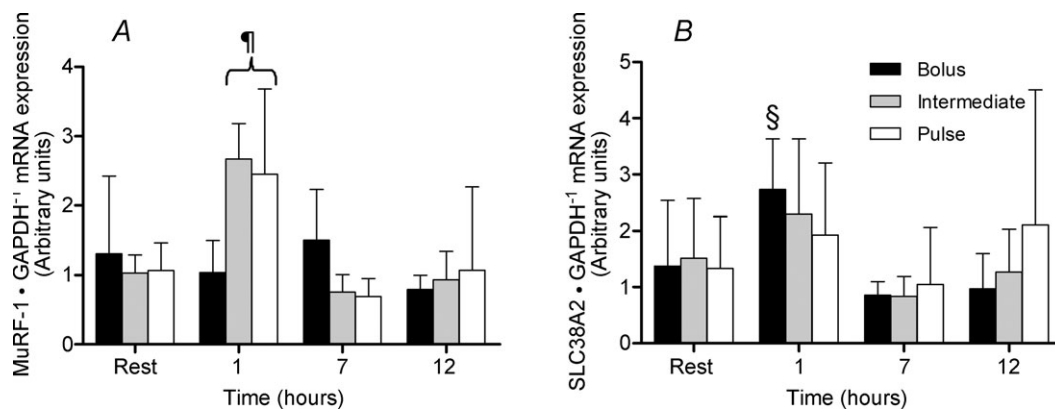

Figure 7

MuRF-1 (A) and SLC38A2 (B) mRNA expression relative to GAPDH following a bout of leg extension resistance exercise and post-exercise BOLUS, INT or PULSE ingestion protocol during a 12 h recovery period, as described in Fig. 2. Data were analysed using a 2-way ANOVA with Student–Newman–Keuls *post hoc* analysis. Values are mean \pm SD. Different vs. §, all time points within group; ¶, all time points within group and Bolus at equivalent time point ($P < 0.05$).

pattern due to irreversible amino acid oxidation of the excess protein (Moore *et al.* 2009a). Given that the fraction of protein that appears in the systemic circulation seems to be constant regardless of the size of the protein meal (Pennings *et al.* 2012), the fate of the amino acids ingested may be in tissues other than skeletal muscle with PULSE and BOLUS feeding patterns. A limitation of the current study is that our results may only be valid for individuals of average body mass (i.e. 70–80 kg). Similar ingestion regimens should be assessed in other populations (e.g. obese) and represent an area for future studies.

The present study did not include an exercise-only intervention but the additive effect of protein ingestion on the anabolic response following resistance exercise is well established and rates of MPS would be superior compared with resistance exercise in isolation regardless of the ingestion protocol (Biolo *et al.* 1995, 1997; Moore *et al.* 2009a). We chose to examine 12 h post-exercise recovery to be representative of multiple daily feeding opportunities. We purposely designed the study to isolate the effects of protein intake and avoid interference by carbohydrate or fat ingestion, as protein alone has been shown to robustly stimulate muscle protein synthesis after exercise (Biolo *et al.* 1997; Tipton *et al.* 1999, 2003; Moore *et al.* 2009a, 2009b; Burd *et al.* 2010; West *et al.* 2011). While individuals in the present study were presumably in negative energy balance over the day of the trial, the majority of studies involving protein feedings are performed after an overnight fast, yet still result in robust increases in resting and exercise-induced myofibrillar protein synthesis (Biolo *et al.* 1997; Tipton *et al.* 1999; Bohe *et al.* 2001; Moore *et al.* 2009a, b; Atherton *et al.* 2010; Burd *et al.* 2010, 2011; West *et al.* 2011). As such, in conditions of energy balance or positive energy balance we would probably have observed a similar, if not greater, MPS response.

The present data extend the findings of previous studies with the novel observation that the pattern of protein intake can modify the extent of muscle protein synthesis during the late (i.e. 6–12 h) period of recovery. In the present study, the cumulative protein intake by the 1–4 h period post exercise was 40 g for BOLUS and INT, and only 30 g for PULSE. Yet despite these different patterns of intake, we and others (Cuthbertson *et al.* 2005; Moore *et al.* 2009a; Pennings *et al.* 2012) have shown that >20 g of protein is sufficient to induce maximal rates of protein synthesis in the early recovery period. The divergence in the MPS response after 4 h, with superior outcomes for INT, suggests that the timing and distribution of protein intake becomes a critical factor for optimizing MPS late in recovery. Our results indicate that 20 g of rapidly digested high-quality protein every 3 h provides both sufficient amino acids and an adequate latency period for repeated stimulation of muscle protein synthesis. The implication is that 40 g of protein every 6 h, which simulates a daily

pattern of 'three square meals', or 10 g of protein every 1.5 h simulating a 'grazing' eating pattern, are inferior in their capacity to stimulate MPS. However, it should be noted that our results apply to rapidly digested whey protein and mixed meal consumption of whole foods, or a slowly digested protein such as casein, would probably reduce the magnitude of plasma aminoacidaemia and subsequent MPS response but intuitively the relative effect of the pattern and timing of protein ingestion would probably remain. Indeed, our findings indicate that individuals who have the goal of maximally stimulating muscle anabolism may benefit from strategies that regularly isolate rapidly digested, high quality protein ingestion from other daily nutrient intakes. Regardless, we suggest that the current population recommendations for protein intake, which are provided as a total daily target without consideration of the pattern of protein intake, should be reassessed in view of the likely impact on muscle protein metabolism and, subsequently, lean body mass. Such a concept has been raised previously when protein metabolism has been estimated from the traditional nitrogen balance techniques (Leverton & Gram, 1949).

Results from our cell signalling data provide new information regarding nutrient–exercise interactions regulating translation initiation events. As might be expected, as a critical node in the insulin signalling network (Taniguchi *et al.* 2006), phosphorylation of Akt^{Ser473} and its downstream targets TSC2^{Thr1472} and PRAS40^{Thr246} corresponded closely to changes in plasma insulin concentration. The mTORC1 regulates metabolic activity and is a focal point for integrating nutrient (i.e. amino acid) and exercise signal transduction (Dreyer *et al.* 2006, 2008; Rivas *et al.* 2009; Camera *et al.* 2010; Terzis *et al.* 2010; Zoncu *et al.* 2011). Interestingly, phosphorylation of Ser2448 was ~2 to ~6-fold above resting values during the entire recovery period independent of the protein ingestion protocol. This is the first study to show prolonged (12 h), sustained increases in phosphorylation of mTOR^{Ser2448} above rest consistent with elevated muscle protein synthesis above rest. Similarly, p70 S6K^{Thr389} phosphorylation increased above rest throughout the recovery period in all ingestion protocols, although the magnitude of the response differed and was dependent on the pattern of protein ingestion (BOLUS>INT>PULSE at the 1 and 7 h recovery time points). As a signalling kinase proximal to translation initiation, p70 S6K is promoted as a physiological marker closely associated with muscle protein synthesis (Baar & Esser, 1999; Kumar *et al.* 2009; Burd *et al.* 2010; Fry *et al.* 2011). We found no correlation between the degree of phosphorylation of S6K and the myofibrillar FSR response ($r = 0.2$). The lack of change in 4E-BP1 Thr37/46 phosphorylation following exercise and protein ingestion was unexpected but has been observed previously (Breen *et al.* 2011; Coffey *et al.* 2011; Burd *et al.* 2012a) and might be attributable to insufficient volume

and/or intensity of exercise or possibly due to competitive interaction with p70 S6K as a raptor substrate (Dennis *et al.* 2013). Similarly, we also failed to see a nutrient-sensitive response for eEF2 phosphorylation which has also been shown by others (Breen *et al.* 2011; Moore *et al.* 2011; Burke *et al.* 2012). Accordingly, our results support the premise that the snapshot provided by quantification of mTOR-S6K phosphorylation is indicative of elevated MPS compared to baseline but does not accurately reflect the magnitude or duration of the MPS response.

Modulating intake of macronutrients also generates changes in transcriptional activity of the muscle cell (Drummond *et al.* 2010; Borgenvik *et al.* 2012). The BOLUS condition induced an early post-exercise increase in mRNA expression of the amino acid transporter SLC38A2/SNAT2 while there was a repressed expression of MuRF-1 compared with INT and PULSE feeding protocols. The increase in amino acid transporter and blunting of ubiquitin ligase expression has been shown previously (Drummond *et al.* 2010; Borgenvik *et al.* 2012) but the physiological significance of such changes has yet to be clearly defined. Nonetheless, our results indicate that a large bolus feeding of amino acids, or possibly high plasma leucine concentrations (Churchward-Venne *et al.* 2012), may be necessary to substantially alter the transcriptional activity in muscle. However, this effect was no longer evident following a second bolus ingestion 6 h later and may indicate that an exercise–nutrient interaction is required to induce changes in transcription of specific gene targets (Drummond *et al.* 2010, 2011). Nonetheless, the possibility exists that a large bolus of protein is advantageous for enhancing AA transporter expression and/or suppressing catabolic activity compared with moderate–small quantities of protein intake during the early post-exercise recovery period.

In conclusion, the results from the current study provide new information demonstrating that the timing and distribution of protein ingestion is a key factor in maximally stimulating rates of MPS throughout an entire day. During the 12 h recovery period after a single bout of resistance exercise 20 g of whey protein ingested every 3 h was the optimal feeding pattern for promoting enhanced rates of MPS in the present study. These results highlight the importance of the interplay between timing and quantity of protein ingestion on MPS over the course of each day and represent an important dietary message that merits consideration for population recommendations for daily protein intake. The chronic effects and practicalities of incorporating such an ingestion strategy within the total daily eating plan including whole foods represent areas for future study. In the meantime, this study emphasizes that the timing of protein intake is a separate variable and a crucial factor in the development of optimal nutritional strategies to maintain and/or enhance peak muscle mass in humans.

References

- Atherton PJ, Etheridge T, Watt PW, Wilkinson D, Selby A, Rankin D, Smith K & Rennie MJ (2010). Muscle full effect after oral protein: time-dependent concordance and discordance between human muscle protein synthesis and mTORC1 signaling. *Am J Clin Nutr* **92**, 1080–1088.
- Baar K & Esser K (1999). Phosphorylation of p70(S6k) correlates with increased skeletal muscle mass following resistance exercise. *Am J Physiol Cell Physiol* **276**, C120–C127.
- Biolo G, Maggi SP, Williams BD, Tipton KD & Wolfe RR (1995). Increased rates of muscle protein turnover and amino acid transport after resistance exercise in humans. *Am J Physiol Endocrinol Metab* **268**, E514–E520.
- Biolo G, Tipton KD, Klein S & Wolfe RR (1997). An abundant supply of amino acids enhances the metabolic effect of exercise on muscle protein. *Am J Physiol Endocrinol Metab* **273**, E122–E129.
- Bohe J, Low JF, Wolfe RR & Rennie MJ (2001). Latency and duration of stimulation of human muscle protein synthesis during continuous infusion of amino acids. *J Physiol* **532**, 575–579.
- Borgenvik M, Apró W & Blomstrand E (2012). Intake of branched-chain amino acids influences the levels of MAFbx mRNA and MuRF-1 total protein in resting and exercising human muscle. *Am J Physiol Endocrinol Metab* **302**, E510–E521.
- Breen L, Philp A, Witard OC, Jackman SR, Selby A, Smith K, Baar K & Tipton KD (2011). The influence of carbohydrate–protein co-ingestion following endurance exercise on myofibrillar and mitochondrial protein synthesis. *J Physiol* **589**, 4011–4025.
- Burd NA, Andrews RJ, West DWD, Little JP, Cochran AJR, Hector AJ, Cashaback JGA, Gibala MJ, Potvin JR, Baker SK & Phillips SM (2012a). Muscle time under tension during resistance exercise stimulates differential muscle protein sub-fractional synthetic responses in men. *J Physiol* **590**, 351–362.
- Burd NA, Groen BB, Beelen M, Senden JM, Gijzen AP & van Loon LJ (2012b). The reliability of using the single-biopsy approach to assess basal muscle protein synthesis rates in vivo in humans. *Metabolism* **61**, 931–936.
- Burd NA, Holwerda AM, Selby KC, West DWD, Staples AW, Cain NE, Cashaback JGA, Potvin JR, Baker SK & Phillips SM (2010). Resistance exercise volume affects myofibrillar protein synthesis and anabolic signalling molecule phosphorylation in young men. *J Physiol* **588**, 3119–3130.
- Burd NA, West DWD, Moore DR, Atherton PJ, Staples AW, Prior T, Tang JE, Rennie MJ, Baker SK & Phillips SM (2011). Enhanced amino acid sensitivity of myofibrillar protein synthesis persists for up to 24 h after resistance exercise in young men. *J Nutr* **141**, 568–573.
- Burke LM, Hawley JA, Ross ML, Moore DR, Phillips SM, Slater GR, Stellingwerff T, Tipton KD, Garnham AP & Coffey VG (2012). Preexercise aminoacidemia and muscle protein synthesis after resistance exercise. *Med Sci Sports Exerc* **44**, 1968–1977.
- Camera DM, Edge J, Short MJ, Hawley JA & Coffey VG (2010). Early time course of Akt phosphorylation after endurance and resistance exercise. *Med Sci Sports Exerc* **42**, 1843–1852.

- Camera DM, West DWD, Burd NA, Phillips SM, Garnham AP, Hawley JA & Coffey VG (2012). Low muscle glycogen concentration does not suppress the anabolic response to resistance exercise. *J Appl Physiol* **113**, 206–214.
- Chesley A, MacDougall JD, Tarnopolsky MA, Atkinson SA & Smith K (1992). Changes in human muscle protein synthesis after resistance exercise. *J Appl Physiol* **73**, 1383–1388.
- Churchward-Venne TA, Burd NA, Mitchell CJ, West DW, Philp A, Marcotte GR, Baker SK, Baar K & Phillips SM (2012). Supplementation of a suboptimal protein dose with leucine or essential amino acids: effects on myofibrillar protein synthesis at rest and following resistance exercise in men. *J Physiol* **590**, 2751–2765.
- Coffey V, Moore D, Burd N, Reracich T, Stellingwerff T, Garnham A, Phillips S & Hawley J (2011). Nutrient provision increases signalling and protein synthesis in human skeletal muscle after repeated sprints. *Eur J Appl Physiol* **111**, 1473–1483.
- Cuthbertson D, Smith K, Babraj J, Leese G, Waddell T, Atherton P, Wackerhage H, Taylor PM & Rennie MJ (2005). Anabolic signaling deficits underlie amino acid resistance of wasting, aging muscle. *FASEB J* **19**, 422–424.
- Dennis MD, Kimball SR & Jefferson LS (2013). Mechanistic target of rapamycin complex 1 (mTORC1)-mediated phosphorylation is governed by competition between substrates for interaction with raptor. *J Biol Chem* **288**, 10–19.
- Dreyer HC, Drummond MJ, Pennings B, Fujita S, Glynn EL, Chinkes DL, Dhanani S, Volpi E & Rasmussen BB (2008). Leucine-enriched essential amino acid and carbohydrate ingestion following resistance exercise enhances mTOR signaling and protein synthesis in human muscle. *Am J Physiol Endocrinol Metab* **294**, E392–E400.
- Dreyer HC, Fujita S, Cadenas JG, Chinkes DL, Volpi E & Rasmussen BB (2006). Resistance exercise increases AMPK activity and reduces 4E-BP1 phosphorylation and protein synthesis in human skeletal muscle. *J Physiol* **576**, 613–624.
- Drummond MJ, Fry CS, Glynn EL, Timmerman KL, Dickinson JM, Walker DK, Gundermann DM, Volpi E & Rasmussen BB (2011). Skeletal muscle amino acid transporter expression is increased in young and older adults following resistance exercise. *J Appl Physiol* **111**, 135–142.
- Drummond MJ, Glynn EL, Fry CS, Timmerman KL, Volpi E & Rasmussen BB (2010). An increase in essential amino acid availability upregulates amino acid transporter expression in human skeletal muscle. *Am J Physiol Endocrinol Metab* **298**, E1011–E1018.
- Fry CS, Drummond MJ, Glynn EL, Dickinson JM, Gundermann DM, Timmerman KL, Walker DK, Dhanani S, Volpi E & Rasmussen BB (2011). Aging impairs contraction-induced human skeletal muscle mTORC1 signaling and protein synthesis. *Skelet Muscle* **1**, 11.
- Glover EI, Phillips SM, Oates BR, Tang JE, Tarnopolsky MA, Selby A, Smith K & Rennie MJ (2008). Immobilization induces anabolic resistance in human myofibrillar protein synthesis with low and high dose amino acid infusion. *J Physiol* **586**, 6049–6061.
- Kumar V, Selby A, Rankin D, Patel R, Atherton P, Hildebrandt W, Williams J, Smith K, Seynnes O, Hiscock N & Rennie MJ (2009). Age-related differences in the dose–response relationship of muscle protein synthesis to resistance exercise in young and old men. *J Physiol* **587**, 211–217.
- Layman D (2009). Dietary Guidelines should reflect new understandings about adult protein needs. *Nutr Metab* **6**, 12.
- Leverton RM & Gram MR (1949). Nitrogen excretion of women related to the distribution of animal protein in daily meals. *J Nutr* **39**, 57–65.
- Livak KJ & Schmittgen TD (2001). Analysis of relative gene expression data using real-time quantitative PCR and the $2^{-\Delta\Delta CT}$ Method. *Methods* **25**, 402–408.
- Moore DR, Atherton PJ, Rennie MJ, Tarnopolsky MA & Phillips SM (2011). Resistance exercise enhances mTOR and MAPK signalling in human muscle over that seen at rest after bolus protein ingestion. *Acta Physiol (Oxf)* **201**, 365–372.
- Moore DR, Robinson MJ, Fry JL, Tang JE, Glover EI, Wilkinson SB, Prior T, Tarnopolsky MA & Phillips SM (2009a). Ingested protein dose response of muscle and albumin protein synthesis after resistance exercise in young men. *Am J Clin Nutr* **89**, 161–168.
- Moore DR, Tang JE, Burd NA, Reracich T, Tarnopolsky MA & Phillips SM (2009b). Differential stimulation of myofibrillar and sarcoplasmic protein synthesis with protein ingestion at rest and after resistance exercise. *J Physiol* **587**, 897–904.
- Paddon-Jones D & Rasmussen BB (2009). Dietary protein recommendations and the prevention of sarcopenia. *Curr Opin Clin Nutr Metab Care* **12**, 86–90.
- Pennings B, Groen B, de Lange A, Gijzen AP, Zorenc AH, Senden JMG & van Loon LJC (2012). Amino acid absorption and subsequent muscle protein accretion following graded intakes of whey protein in elderly men. *Am J Physiol Endocrinol Metab* **302**, E992–E999.
- Phillips SM, Tipton KD, Aarsland A, Wolf SE & Wolfe RR (1997). Mixed muscle protein synthesis and breakdown after resistance exercise in humans. *Am J Physiol Endocrinol Metab* **273**, E99–E107.
- Phillips SM & Van Loon LJ (2011). Dietary protein for athletes: from requirements to optimum adaptation. *J Sports Sci* **29** (Suppl. 1), S29–38.
- Rennie MJ, Edwards RH, Halliday D, Matthews DE, Wolman SL & Millward DJ (1982). Muscle protein synthesis measured by stable isotope techniques in man: the effects of feeding and fasting. *Clin Sci (Lond)* **63**, 519–523.
- Rivas DA, Lessard SJ & Coffey VG (2009). mTOR function in skeletal muscle: a focal point for overnutrition and exercise. *Appl Physiol Nutr Metab* **34**, 807–816.
- Taniguchi CM, Emanuelli B & Kahn CR (2006). Critical nodes in signalling pathways: insights into insulin action. *Nat Rev Mol Cell Biol* **7**, 85–96.
- Terzis G, Spengos K, Mascher H, Georgiadis G, Manta P & Blomstrand E (2010). The degree of p70S6K and S6 phosphorylation in human skeletal muscle in response to resistance exercise depends on the training volume. *Eur J Appl Physiol* **110**, 835–843.
- Tipton KD, Borsheim E, Wolf SE, Sanford AP & Wolfe RR (2003). Acute response of net muscle protein balance reflects 24-h balance after exercise and amino acid ingestion. *Am J Physiol Endocrinol Metab* **284**, E76–E89.

- Tipton KD, Ferrando AA, Phillips SM, Doyle D Jr & Wolfe RR (1999). Postexercise net protein synthesis in human muscle from orally administered amino acids. *Am J Physiol Endocrinol Metab* **276**, E628–E634.
- West DW, Burd NA, Coffey VG, Baker SK, Burke LM, Hawley JA, Moore DR, Stellingwerff T & Phillips SM (2011). Rapid aminoacidemia enhances myofibrillar protein synthesis and anabolic intramuscular signaling responses after resistance exercise. *Am J Clin Nutr* **94**, 795–803.
- West DWD, Burd NA, Churchward-Venne TA, Camera DM, Mitchell CJ, Baker SK, Hawley JA, Coffey VG & Phillips SM (2012). Sex-based comparisons of myofibrillar protein synthesis after resistance exercise in the fed state. *J Appl Physiol* **112**, 1805–1813.
- Wilkinson SB, Tarnopolsky MA, MacDonald MJ, MacDonald JR, Armstrong D & Phillips SM (2007). Consumption of fluid skim milk promotes greater muscle protein accretion after resistance exercise than does consumption of an isonitrogenous and isoenergetic soy-protein beverage. *Am J Clin Nutr* **85**, 1031–1040.
- Zoncu R, Efeyan A & Sabatini DM (2011). mTOR: from growth signal integration to cancer, diabetes and ageing. *Nat Rev Mol Cell Biol* **12**, 21–35.

Authors contributions

J.L.A., L.M.B., D.R.M., T.S., S.M.P., J.A.H. and V.G.C. designed the research; J.L.A., D.M.C., L.M.B., E.M.B., M.L.R., D.W.D.W., N.A.J. and V.G.C. conducted the research; J.L.A., D.M.C., D.W.D.W., S.M.P., J.A.H. and V.G.C. analysed the data; J.L.A., L.M.B., J.A.H., S.M.P., T.S., D.R.M. and V.G.C. wrote the paper; J.L.A., J.A.H. and V.G.C. have primary responsibility for the final content. All authors have read and approved the final manuscript.

Acknowledgements

This study was funded by Australian Research Council Linkage Project grant (LP100100010). The authors thank Greg Shaw, Alisa Nana, Joanne Mirtschin, Christine Dziedzic, Siobhan Moran, Lynne Mercer, Felicity Galvez, Eric Haakonsen, Jesse Featonby and Tracy Rerecich for technical assistance during experimental trials and laboratory analysis. D.R.M. and T.S. were employed by Nestlé Research Center in Lausanne, Switzerland for the duration of the study. All the other authors report no conflict of interest.