

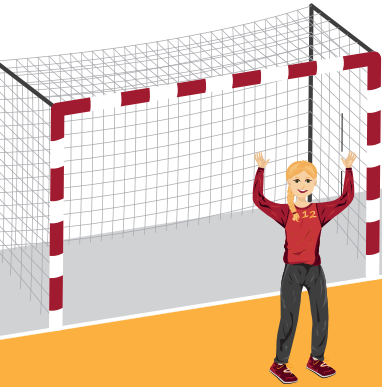

# TEACHING HANDBALL

## VOLUME 1: TEACHER GUIDELINES

HANDBALL  
AT SCHOOL | FUN,  
PASSION  
AND HEALTH



I need to focus on the ball.

Can I intercept the ball?

Should I move away or give support?



Should I pressure?

Am I well positioned?



What should I do?



## TEACHING HANDBALL

### VOLUME 1: TEACHER GUIDELINES

Dr Ilona Hapková  
Dr Luísa Estriga  
Craig Rot





**Title of booklet series:** TEACHING HANDBALL

**Title of volume 1:** *Teacher Guidelines*

**Editor:** Dr Ilona Hapková

**Created by Handball at School working group:** Dr Ilona Hapková, Dr Luísa Estriga, Craig Rot

**Graphics designer:** Barbora Nemethová

**Photos:** IHF database, Ivan Dostál

**Language revision:** Craig Rot

**Reviewer:** Dr František Táborský, Dietrich Späte

**Publishing house:** Police Press, Al-Moror-Str. Al-Darasa, Cairo, Egypt

**Produced by International Handball Federation 2019**

All rights reserved to International Handball Federation.  
Reproduction only with permission of the IHF and full details of source.





<b>1 EDITORIAL</b> .....	<b>8</b>
<b>2 BRIEF HISTORY OF HANDBALL</b> .....	<b>9</b>
<b>3 OVERVIEW OF DIFFERENT TYPES OF HANDBALL</b> .....	<b>11</b>
<b>4 BASIC STRUCTURE AND TERMINOLOGY</b> .....	<b>13</b>
<b>4.1</b> Breaking Down the Game	
<b>4.2</b> Terminology and Symbols	
<b>4.3</b> Handball Facilities	
<b>4.4</b> Light Version of Rules	
<b>4.5</b> Handball Equipment	
<b>5 HANDBALL AT SCHOOL PHILOSOPHY</b> .....	<b>35</b>
<b>6 METHODOLOGY AND APPROACH OF TEACHING HANDBALL</b> .....	<b>37</b>
<b>6.1</b> Learning by Doing Methodology	
<b>6.2</b> Handball Game-Based Approach	
<b>6.3</b> Implementing the Handball Game-Based Approach	
<b>6.4</b> Unit Planning	
<b>6.5</b> Lesson Planning	
<b>7 BASIC COLLECTIVE PLAY</b> .....	<b>55</b>
<b>7.1</b> Attack	
<b>7.2</b> Defence	
<b>8 HANDBALL SKILLS AND TECHNIQUES</b> .....	<b>63</b>
<b>8.1</b> Basic Attacking Skills	
<b>8.2</b> Basic Defence Skills	
<b>8.3</b> Basic Goalkeeping	

---

<b>9</b>	<b>CHARACTERISATION OF STAGES IN THE TEACHING PROCESS</b> .....	<b>78</b>
	<b>9.1</b> Beginner Level – Mini Handball	
	<b>9.2</b> Intermediate Level – Transition to Handball	
	<b>9.3</b> Advanced Level – Handball	
	<b>9.4</b> Assessment and Check Points	
	<b>9.5</b> Selecting and Long-Term Talent Development	
<b>10</b>	<b>CURRICULUM</b> .....	<b>99</b>
	<b>10.1</b> Novice School Curriculum	
	<b>10.2</b> Beginner School Curriculum	
	<b>10.3</b> Intermediate School Curriculum	
	<b>10.4</b> Advanced School Curriculum	
<b>11</b>	<b>ORGANISATION OF HANDBALL EVENTS IN SCHOOLS</b> .....	<b>105</b>
	<b>11.1</b> Festivals	
	<b>11.2</b> Tournaments	
	<b>11.3</b> Leagues	
<b>12</b>	<b>ACKNOWLEDGEMENTS</b> .....	<b>111</b>
<b>13</b>	<b>REFERENCE</b> .....	<b>112</b>
<b>14</b>	<b>APPENDIX</b> .....	<b>113</b>
	<b>14.1</b> Developing Scope and Sequence of Lesson Planning	
	<b>14.2</b> Example of Lesson Form	
	<b>14.3</b> Guide for Events in Schools	





*In recent years, handball has become one of the most popular sports in the world. The development of the sport has been greatly influenced by its dynamic game play and attractiveness to spectators.*

*Because players must quickly analyse the fast-changing circumstances of the game and act accordingly in varying situations, handball provides children the opportunity to solve key game problems through physical activity, developing important physical, psychological and social skills that will benefit them throughout their lives.*

*In 2011, the International Handball Federation launched Handball at School, a worldwide training and education programme for Physical Education teachers. Under the motto 'fun, passion and health', we set out to revolutionise the teaching of handball in schools by creating a universal*

*programme that would increase participation in and awareness of our great sport.*

*In the first seven years of this programme, we have carried out more than 90 interventions around the world, and with the help of our hosting federations, we have identified and developed more than 260 new epicentres for the sport's growth.*

*Focusing on introducing handball to physical education teachers who work with pupils from the ages of 5 to 17, we intend for this booklet to be used by teachers for all Handball at School Level 1 and National/Continental multipliers courses, as well as for obtaining corresponding IHF coaching licences.*

*I am convinced that the Handball at School programme will provide the opportunity to introduce and retain a whole new generation of youngsters, teachers, leaders and also coaches for handball.*

**Dr Hassan Moustafa**

IHF President



## 2. BRIEF HISTORY OF HANDBALL



Games similar to handball have historically been played in different variations and in many different cultures around the world. Played on fields similar in size to an actual handball court, these games had their own unique set of rules, varying from penetrating a zone with possession of the ball, shooting the ball at a hoop or net, to throwing at a goal in a similar fashion to the modern game.

At the beginning of the 20th century, the first rules for games similar to handball were written, especially in Denmark (Håndbold), Czechia (Házená) and Germany (Feldhandball). A common set of rules was established and the first national and international associations were created to govern, promote and develop the sport.

In 1936, field handball (Feldhandball) debuted at the Olympic Games in Berlin. For simplicity, the term handball (also known as Olympic handball or team handball) will be used for the game with seven players on the court for each team.

In 1946, the International Handball Federation (IHF) was established, modernising the game to be played on an official court as it is today. Handball became an official Olympic sport for men at the 1972 Olympic Games in Munich, and for both genders at the 1976 Olympic Games in Montreal.



*Field handball (11-a-side)*



*Handball (7-a-side)*

---

Further refinements of the rules have focused on creating a more dynamic and exciting game, while also improving player safety. These rules changes include the number of players in a team, fast throw-offs after goals, passive play and changes meant to limit overly aggressive defensive play by involving progressive punishments such as yellow cards, two-minute suspensions, five-minute suspensions, and red cards.

The latest set of improvements, which debuted at the 2016 Olympic Games in Rio, adjusted the rules by allowing an extra attacking player in exchange for an undefended goal, creating a better-defined rule for passive play, and introducing blue cards, which are designated for the most flagrant of actions. Included amongst these new rule changes was also the introduction of a new rule for mandatory suspension for 3 offensive possessions for excessive medical treatment.

These developments at the end of the 20th century and the beginning of the 21st century have seen an increase in handball's growth and popularity with the International Handball Federation not just overseeing the sport's crowning tournaments, the Youth, Junior and Senior World Championships and the Olympic Games, but also its expansion across the globe, as with outreach programmes like the IHF Trophy.

In addition, the IHF Coaches and Teachers Education System encompasses a large number of coaching courses for different levels, including special courses for emerging national federations, Olympic Solidarity courses in cooperation with the International Olympic Committee, and, of course, Handball at School courses, all of which ensure a bright future for the sport.



*Handball  
at the Olympic Games*



*Men's Handball World Championship*

### 3. OVERVIEW OF DIFFERENT TYPES OF HANDBALL



Handball is a popular sport enjoyed by millions of people worldwide. The key aspects of the sport, dynamic, fast-paced, and quick changing game play, make for an exciting game to play and an attractive sport to watch. Handball adapts well to different conditions and needs, creating fun and engaging variations that can be played by just about anyone anywhere at any time. Whether it is on sand, grass, asphalt, court or snow, more and more people enjoy the sport of handball every year.

#### HANDBALL



Handball is played on a rectangular court of 40 x 20 metres. The goals at each end are bounded by a goal-area line of 6 metres, roughly curved, and in which only the team's goalkeeper can act. A player is allowed to hold the ball for up to 3 seconds, to move holding the ball for a maximum of 3 steps and to dribble until being stopped. The defender may fight for possession of the ball and prevent the opponent from shooting at the goal as long as the player does not grab, push or otherwise endanger the opponent's physical integrity.

#### MINI HANDBALL

Mini handball is a tool to teach handball, with rules adapted to make the game accessible, challenging and enjoyable for children. Therefore, it is up to the PE teacher or coach to shape the rules appropriately with freedom submitted only to the utility principle – if a change of rule is useful to teach something (technically or tactically), then, change the rule. Five against five on a smaller field is popular, but there are no limitations to the adaptations that can be made.



#### BEACH HANDBALL



Created in the 90s, beach handball features many of the best qualities of handball, with fast-paced game play and spectacular goals, but has taken much of the contact out of the game, and rewards creativity and risk with 2 points for goals scored under certain dynamic conditions. A team is comprised of three field players and a goalkeeper. Beach handball is played with two timed halves, and each half must have a winner, similar to winning a set in tennis. If the game is tied at the end of regulation, a series of shoot-outs is played until a winner is found.

## WHEELCHAIR HANDBALL



At the beginning of the 21st century, wheelchair handball was developed to make handball accessible to people with motor disabilities. The rules closely align with those of handball with several key changes, including a reduced number of players, a smaller goal, rules focused on pushing, dribbling and passing, safety measures for equipment to ensure player safety, and the promotion of mixed gender teams.

## STREET HANDBALL

Played with a soft, non-bouncing ball, street handball shares the philosophy of mini handball: fluid rules, adaptable to include everyone across gender and ages, and to accommodate on any open-air field. It is usually a four-a-side game, and any player can be goalkeeper. All players can attack, playing with numerical advantage (4 vs. 3 plus goalkeeper). Teams are not allowed to attempt to score until all its players have touched the ball, dribbling is not allowed, and physical contact is strictly forbidden.



## SNOW HANDBALL



Following the lead of street and beach versions of handball, snow handball has found a foothold in wintry climates, and is currently the youngest branch of this popular game. It includes many elements of beach handball, and could become very popular in countries with a lot of snow.

***The use of elements from all types of handball is very enriching during the teaching process, engaging students in alternative and creative ways to learn how to play. For this booklet and its subsequent volumes, we will mainly deal with the teaching of mini handball and handball.***

Before we can move into the core aspects of this programme, it is important to familiarise oneself with a breakdown of the games of mini handball and handball, its basic terminology and symbols, the facilities required to play, and an overview of the rules, all of which we will explore in greater detail in this chapter.

### 4.1 Breaking Down the Game

#### MINI HANDBALL

In mini handball, a team consists of four court players and a goalkeeper (4+1), the game is played as a contact-avoiding variation of handball, and a team can be made up of boys and girls. At this crucial developmental stage, players are encouraged to play man-to-man defence, and therefore do not play offensive or defensive positions. This critical aspect of mini handball helps young players gain valuable experience learning individual technical-tactical skills and improve basic group-tactical concepts. Played with a modified soft-skinned ball, mini handball also provides young players the opportunity to safely and properly learn the goalkeeper position.

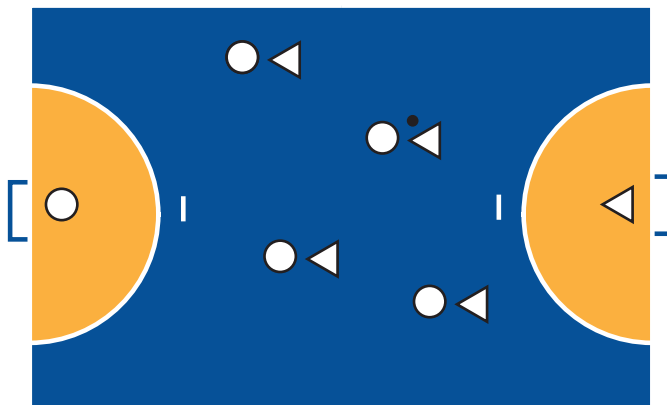

*Players on the court of mini handball*

In this 4+1 construct, it is important that all players, no matter their gender, size, shape, handedness or skill level, get as many opportunities as possible to pass, catch and dribble, to control and manipulate space, to fake a defender, and of course, to face shots on goal. Played on a smaller court, mini handball is fast moving and transitions quickly between offensive and defensive phases of the game, providing players with similar tasks throughout each phase as in handball.

As players develop through puberty and learn 5+1 (beginning of positional attack and defence without pivot) and 6+1 constructs of the sport, certain factors like height, physical strength, jumping ability, speed, mental toughness and arm strength will guide them towards positions on the court. It is very important that players learn all positions on the court before specialising.

## HANDBALL

Playing on an official court, handball is a contact sport played in four phases: positional attack, transition defence, positional defence, and transition offence. With regard to youth teams, the use of offensive and defensive specialists should be avoided. We will use these basic phases, in the above order, to examine the positions and tactical roles of players on the court throughout a game.

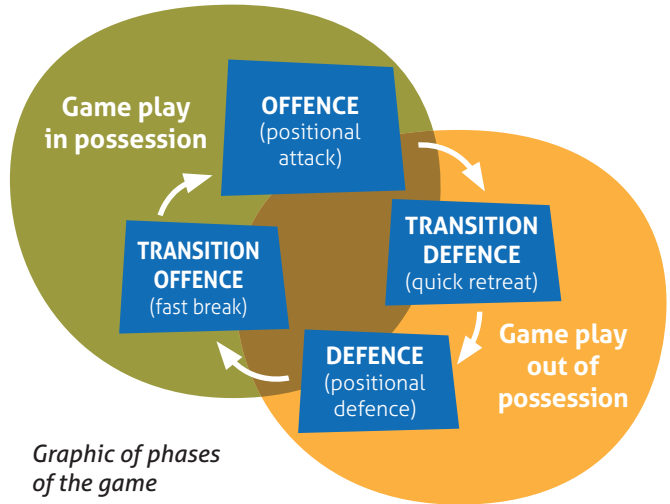

*Graphic of phases of the game*

In **positional attack**, players generally take up two positional groups: forward players and back-court players. Players of the forward line typically consist of a pivot (also known as line player or circle runner), a player who positions himself/herself between the defenders near the goal area, and two wings that position themselves in the corners, align themselves to benefit from handedness, and attack the flanks of the defence. In the back-court line, we have a centre back (also known as playmaker), and left and right backs, which, like the wings, align themselves to handedness, but specialise in outside shooting, dynamic attacking, and collaborating with the pivot.

The 3:3 offensive formation, pictured below, is the most common offensive formation in handball, but is not the only offence, a matter we will examine in greater detail later in this book and subsequent volumes.

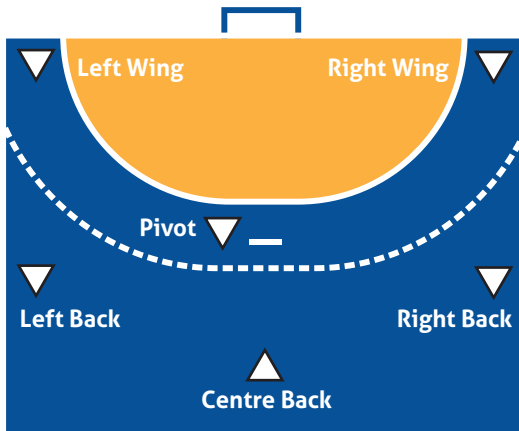

*Positions in 3:3 offensive formation*

In **transition defence**, players retreat with several objectives, depending on a player's proximity to the ball. These objectives include forcing turnovers or technical mistakes, preventing easy scoring opportunities, and organising into a cohesive defensive unit.

In **positional defence**, teams may adopt one of three basic defensive concepts: man-to-man defence, zone defence or combined defence. For simplicity's sake, we will first examine the most common defence in handball, the 6:0 zone defence, where we find all six defenders formed immediately in front of the goal area.

We usually group defensive players into three distinct roles: outside defenders, half defenders and inside defenders (sometimes called central half defenders). An easy numerical system from 1 to 3 can also be used to number these positions, beginning with the outside defenders. Both systems are elaborated below.

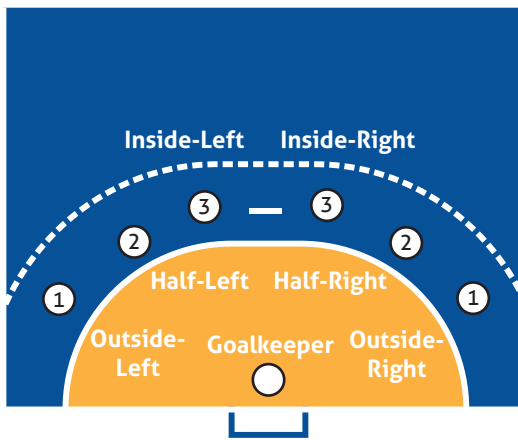

*Positions in 6:0 defensive formation*

The first priority of defence is to win the ball. The responsibilities and duties of the defenders vary from moment to moment, but it is commonly understood that defences are most vulnerable in the middle, where high percentage shots are most numerous. Therefore, the most skilled defenders tend to manage the centre of the line. Variations in defensive shape and tactics will be explained later in this book.

The goals of the positional defence are to prevent the attack from gaining positional, temporal-spatial and/or numerical advantages, to deny them access to spaces of great value, and to force low percentage shots, technical errors, and turnovers, all of which will be capitalised on immediately.

In **transition offence**, forward players and back-court players generally maintain unit cohesion in their advance up the court, as these groups move from simple to extended to complete fast breaks, all of which will be explained in greater detail later in this book.

---

## 4.2 Terminology and Symbols

To effectively utilise this programme, it is important to begin with a common set of terms and symbols, which will be used throughout this booklet and subsequent volumes.

### TERMINOLOGY

**Attack:** The team's activity that begins with gaining possession of the ball and ends with losing possession of the ball.

**Attacker:** Member of attacking team.

**Break-through:** When an attacker penetrates the defence and creates a close-range shooting opportunity.

**Defence:** The team's activity that begins with losing possession of the ball and ends with regaining possession of the ball.

**Defender:** Member of defending team.

**Dribbling/Bouncing:** In handball, attacking players are allowed to repeatedly hit the top of the ball with their hand whether they are standing in the basic position or moving up the court. Unlike basketball, attacking players are not allowed to palm, carry, or manoeuvre the ball in such a way as to break this striking pattern.

**Faking:** An essential element to all attacking situations is the use of faking, which includes **pass faking**, **shot faking** and **body faking**. The purpose of faking is to disengage from the defender, to move the goalie into a disadvantageous position, or to create space during pressure play (see below). Fakes have two primary phases: the first is the prompt, which is the suggestion of a movement or technique, and the second is the escape, which follows immediately after the defender's movement, and must be made very quickly to take advantage of the opening. Fakes can be made by attackers without and with the ball.

**Fast break:** The fast break is the period immediately after the defence regains possession of the ball, and includes three phases (waves): **simple fast break**, **extended fast break**, and **complete fast break**. These waves move from individual to small group (usually with numerical advantage) to the entire unit taking advantage of a defence that has not fully formed into a cohesive unit.

**Marking:** The most basic form of defence in handball, marking, is a man-to-man defence that is introduced to small children during Handball at School and mini handball. The use of marking is an important tactical element for children to learn, as it creates a favourable environment for young players to learn essential 1v1 playing skills.





**Passing:** Throwing the ball to a teammate.

**Penetration:** When the offence gains a high percentage shot by moving through two defenders.

**Piston movement:** A technical-tactical element executed in attack by continually moving forwards and backwards.

**Pressure play:** A tactical element where a small group of attacking players work together using an array of technical-tactical elements to create a high percentage scoring opportunity by attacking multiple gaps at the same time.

**Side-stepping:** The basic movement for attacking players, side-stepping, is a lateral technical footwork movement used to evade defenders.

**Shooting:** A vitally important skill at all levels in handball, shooting has a range of movements and arm positions that vary from situation to situation, and whether the attacker is attempting a lower percentage through-shot (past a defender) or a higher percentage break-through (alone against a goalkeeper). At its most basic, shooting is an **overarm shot**, but considering the many variations, and their uses throughout a game by forward and back-court players, shooting is a cluster of complex techniques that vary in effectiveness based on many factors, including individual preference and developmental circumstances. A list of common shots includes but is not limited to **jumping, running, set, diving, falling, underarm, curved, lob** and **spin** shots, all of which will be discussed in greater detail below.

**Stepping out:** The basic movement of the defender when applying pressure to the attacker with or without the ball in order to prevent goal shooting, to disrupt continuity of the attack and to intercept passes.

**Strategy:** The overall plan to achieve a goal.

**Tactic:** An action a player, group or team takes using a series of technical elements to achieve desired goals.

























**Technique:** A movement created within the limitations of the rules.

**Through-shot:** A scoring attempt from long range that attempts to go through or over the defensive line.

---

## SYMBOLS

### Glossary of basic symbols:

	Attacker or goalkeeper of the team in possession of the ball
	Defender or goalkeeper of the team out of possession of the ball
	Ball
 or 	Attacker with the ball
 	New position of attacker / defender / goalkeeper
 	Orientation of attacker / defender / goalkeeper
	Supporter
	Coach
	Path of player
	Path of pass
	Attacker moving with the ball (1, 2 or 3 steps)
	Attacker bouncing/dribbling the ball
	Defensive blocking
 [or 	Screening
	Faking movement without the ball
	Faking movement with the ball
	Pass fake
	Path of shot
	Shot fake
	Cone

## 4.3 Handball Facilities

Handball can be played inside and outside on almost any type of surface (grass, sand, concrete, earthen or any other surface) and within flexible court sizes.

### MINI HANDBALL COURT

Beginners should start playing handball on smaller playing fields (20 x 13 m) and with a reduced number of players (4 against 4 plus goalkeepers) in order to avoid an excessive demand on the students and to increase the number of situations in which they throw at the goal, so that the students have a feeling of success.

The longer boundary lines are called side lines, and the shorter ones are called goal lines (between the goalposts) or outer goal lines (on either side of the goal).

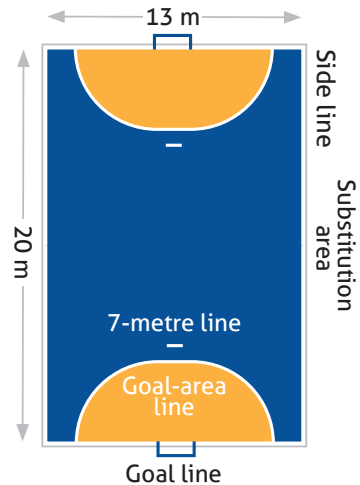

The goal area is defined by the goal-area line (circle or rectangle) at a distance of 4 to 5 metres. There are three possibilities when marking the goal area.

#### The goal area is drawn as follows:

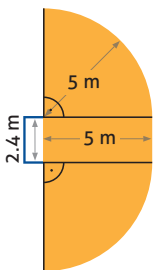

2.4-metre long line directly in front of the goal; this line is parallel to the goal line and 5 metres away from it (measured from the rear edge of the goal line to the front edge of the goal-area line). And two quarter circles, each with a radius of 5 metres (measured from the rear inner corner of the goalposts), connecting the 2.4-metre long line with the outer goal line.

#### Alternative goal areas:

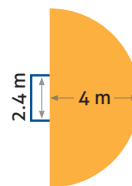

Semi-circle with a radius of 4 metres (measured from the middle of the goal). This dimension is suitable for novices. For beginners, the radius is 5 metres.



The goal area is a rectangle, like a beach handball court. This goal-area line is at a distance of 4 to 5 metres.

**Note:** To mark a mini handball court, we can use different materials such as adhesive tape, chalk, sand (light, dark), fabric line, plastic line, etc. We can also trim lines in the grass with a mower, excavate grooves, etc.

## HANDBALL COURT

The playing court is a 40-metre long and 20-metre wide rectangle, consisting of two goal areas and a playing area. The names of the principal lines on a handball court correspond with those on a mini handball court. On a handball court, there should be a safety zone of 1 metre along the side lines and 2 metres behind the goal lines. The characteristics of the playing court must not be altered during the game in such a way that one team gains an advantage.

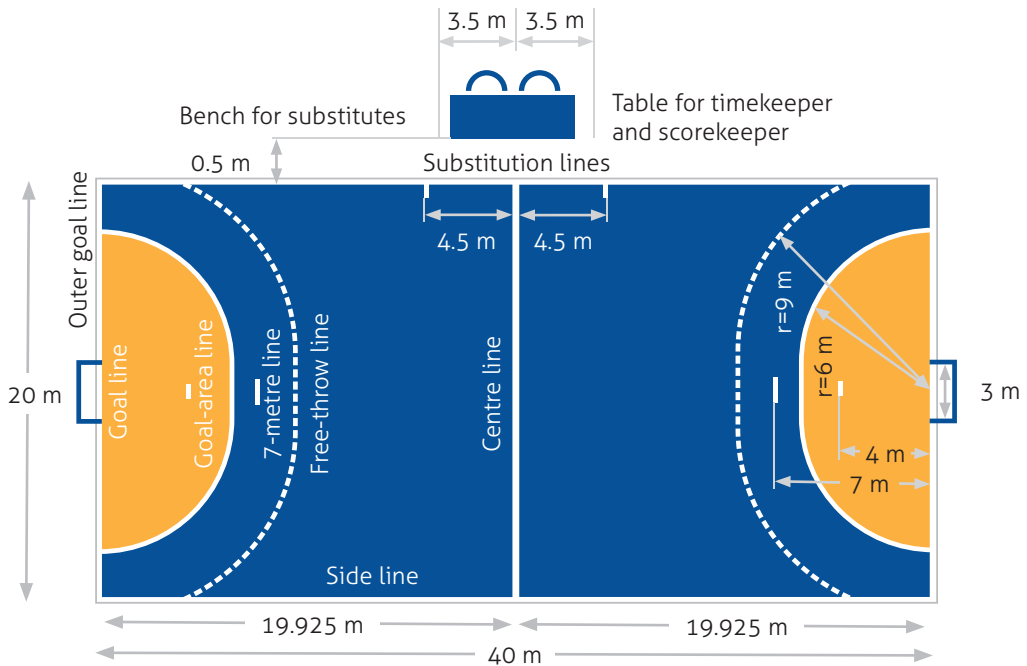

In front of each goal is the goal area. The goal area is defined by the goal-area line (6-metre line), which is drawn as follows:

- 3-metre long line directly in front of the goal; this line is parallel to the goal line and 6 metres away from it (measured from the rear edge of the goal line to the front edge of the goal-area line);
- Two quarter-circles, each with a radius of 6 metres (measured from the rear inner corner of the goalposts), connecting the 3 metres long line with the outer goal line.

The lines of the official court are 5 cm wide, however, the goal lines shall be 8 cm wide between the goalposts.



## 4.4 Light Version of Rules

Handball is a team sport based on **fair play** principles. Learning to play handball is very easy, and you will learn it quickly, but you first need to know some of the rules.

The aim of the game is to throw (shoot) the ball into the goal of the opposing team to score a goal and to avoid throws (shots) at the own goal. The team that scores more goals under the rules at the end of the playing time wins the game.

There are a lot of rules, especially with handball, and since there can be no uniform Handball at School game, we will provide you with some recommendations from the IHF Working Group for Handball at School for the basic format of the game. Let's call these recommendations the 'light version of the rules'.

Each country must have the freedom to play and promote handball according to its own resources and requirements! Handball at School should encourage animation and motivation for the game and for sport in general in our youngest members.

### MINI HANDBALL

#### **Recapitulation:**

Court:	20 m x 13 m	Gender:	Mixed
Size of goal:	2.4 m x 1.6 m	7-metre line:	5 to 6 m
Size of goal area:	4 to 5 m	Free-throw line:	No
Size of ball:	0 or 1	After scoring a goal:	Goalkeeper throw
Number of players:	4 + GK	Duration:	Variable

The Handball at School rules are the basis of mini handball for beginners and/or children under 11. The rules regarding technical faults shall be assessed according to the skills and the age of the children participating in the game. For this level, physical contact with the attacker with the ball must be avoided.

Boys and girls can play together in mixed teams consisting of 4 field players and 1 goalkeeper. Generally, a mini handball team has 7-12 players.

All field players on a team wear identical uniforms. Goalkeepers are not obliged to wear a uniform that is different from those of the field players. Within each team the players are interchangeable during the game without limitation through the substitution area near the bench of the team.

The duration of the match can be variable according to the time considerations of the event (number of teams, duration of event, number of playing courts, etc.). Games are played with two halves (playing time can be 7, 10, 12, 15 min, etc.), with a break (1, 2, 3, 4 or 5 min, etc.) in between, with or without changing sides. There is also the possibility to play without a break, making a game 10, 12, 15 or more minutes.

## HANDBALL

### Recapitulation:

Court:	40 m x 20 m
Size of goal:	3 m x 2 m
Size of goal area:	6 m
Size of ball:	1, 2 or 3
Number of players:	6 + GK

Gender:	Male/Female
7-metre line:	7 m
Free-throw line:	9 m
After scoring a goal:	Throw-off
Duration:	Variable (2 x 30 min)

In handball, there are two male or two female teams playing against each other. A team consists of 6 field players and 1 goalkeeper, and there can be a total of 10 to 16 players on a handball team all together.

For official matches, a game is played as two 30-minute halves, with a ten-minute break in between, but for younger players, the games are shortened to suit the respective age groups. All precedent rules from mini handball are valid for handball.

## GOALKEEPER

*The goalkeeper is allowed to:*



Use all of his/her body to save the ball inside the goal area.



Outside of the goal area, the goalkeeper must act as a court player because only inside the goal area, he/she moves without limitation.

**The goalkeeper is not allowed to:**



Bring a ball back into the goal area while standing in the goal area.



Return to the goal area from the field while in possession of the ball.



Leave the goal area while in possession of the ball.

Teammates are not allowed to pass the ball back to the goalkeeper if he/she is in the goal area.

**Consequence:** lose possession of the ball, free throw.

**FIELD PLAYERS**

With or without possession of the ball, field players move along the whole court from one goal area to the other. Field players are not allowed to enter the goal areas.

**The attacker in possession of the ball is allowed to:**



Take one, two or three steps while holding the ball.



Hold the ball for less than 3 seconds without movement or dribbling.

Bounce as many times as the player wants, but if the attacker stops dribbling, he/she is allowed to take a maximum of three steps before passing or shooting.

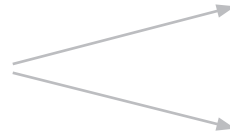

Pass or shoot, leaping above the goal area (making sure to jump before the goal-area line), but must not set foot in it while being in possession of the ball.



---

The attacker is not allowed to run right into an opponent or push him/her if he/she stands in the way.

**Consequence:** lose possession of the ball, free throw and/or progressive punishment.

Technical faults by the attacker result in losing possession of the ball (free throw for opponent from the place where the fault was made).

**Note:** For beginners, we can be more lenient, allowing four steps, incorrect dribbling technique, small part of the foot in the goal area, etc. We try to promote the continuity of the game and have the advantage in case of a minor error, and after the end of the situation, we warn the player of an error or explain the rules again.

### **The defender is allowed to:**

Control and prevent an attacking player from shooting at the goal or making a break-through through his/her positioning. By waving his/her arms in this defensive position, the player can reduce the field of vision of the attacker. The defender can use his/her arms to disrupt the attack, intercept the ball, block the shot, or break up the pass.

For the beginner's level, we recommend the 'protected ball rule', meaning that physical contact with the attacker with the ball should be avoided.



**Body contact while facing an attacker in a one-on-one situation is usually introduced at intermediate level during the transition phase to handball.** With this foul, the defender disrupts the continuity of the game and a possible preparatory phase advantageous for the shooting position.

After stepping out, the defender stands in a wide position, placing the foot to the throwing arm side of the attacker slightly forward, keeping his/her knees bent, using small and fast steps to grab the attacker's hand with the ball with one hand while placing his/her other hand to the attacker's torso.

**Consequence:** attacking team keeps possession of the ball and has free throw from the place where the fault was made, but outside of the free-throw line.

**Note:** Handball is a contact sport and some faults are considered tactics of the game, including interruption of game fluency, disruption of the attacking phase, prevention of obtaining favourable scoring situations, etc.



**The defender is not allowed to:**



Push, hold, restrain or hit attacker without/with the ball.

**Consequence:** free throw, progressive punishment.



Stand/defend in the goal area.

**Consequence:** 7-metre throw.



- Interfere with attacker by using his/her feet (kick).

**Consequence:** free throw, progressive punishment.

- Hit or snatch the ball out of the attacker's hands.

**Consequence:** free throw, progressive punishment.

- Strike or pull back the attacker's throwing arm.

**Consequence:** free throw or 7-metre throw, progressive punishment.

- Spoil a chance of scoring with illegal means.

**Consequence:** free throw or 7-metre throw, progressive punishment.

**All deliberate physical contact between the players shall be avoided in mini handball.**

**Note:** In mini handball, progressive punishment is not applied. Instead, we try to explain to the player the violation of the rules and encourage them to follow the spirit of 'fair play'. If a player continues to violate the rules, we can exchange them for another player.

## REFEREEING

Just as we educate court players from a young age, we should educate referees too. Do not hesitate to give children the possibility to gain experiences as a referee to learn decision-making, analysis of situations, and application of the rules. Refereeing should be included from the beginning of the learning process of handball.

One or two referees with equal authority shall be in charge of each game. They are assisted by a timekeeper and a scorekeeper. The most important decision-making principle for a referee is whistling. In the situation that a referee sees a violation of the rules, he/she must whistle (there are a few exceptions when the referee will not whistle, e.g., out of bounds, corner, etc.). The referee must immediately show the direction of the throw, which is followed by the hand signal for the corresponding rule violation.

***In handball, there are five different throws:***



**Throw-off** is taken at the beginning of each half and after scoring a goal in handball. The referee confirms this rule with one short whistle signal and this hand signal.



**Throw-in** is taken if an opposing player throws the ball over the side line (without any whistle signal from the referee).

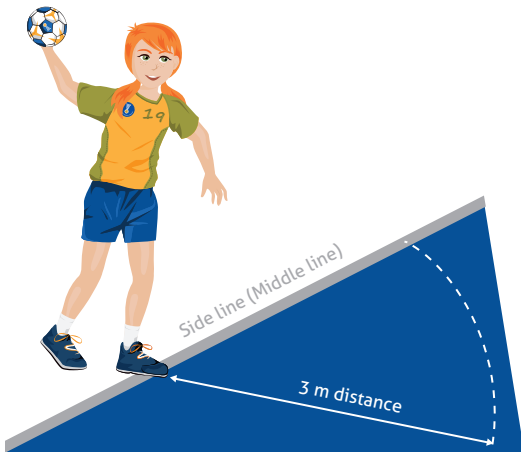

**During the execution** (throw-off and throw-in), the thrower must have one part of a foot in constant contact with the line until the ball is released. The other foot may be lifted and put down repeatedly. Opponents must observe a distance of at least 3 metres from the thrower.



**Free throw** is given to the opponent if a player violates the rules.

The free throw is normally taken without any whistle signal from the referee and, in principle, from the place where the infraction occurred. The attacker is not allowed to execute a free throw between the goal-area line and the free-throw line.



**A goalkeeper throw** is taken after saving a shot by the goalkeeper, or if the attacker enters the goal area while possessing the ball. In mini handball, a goalkeeper throw is made immediately after scoring a goal.

The goalkeeper throw is taken by the goalkeeper without whistle signal from the referee, and from the goal area out into the playing area.

**7-metre throw** is given when a clear scoring chance is destroyed or by the rules governing the last 30 seconds of a half.

The player who is making the 7-metre throw must take up a position behind the 7-metre line, while all court players remain behind the free-throw line, giving the shooter at least 3 metres of space to shoot after one short whistle signal.



**Note:** The attacker is making a throw from the place where the fault/mistake was made, but outside of the free-throw line. Defenders must be at least 3 metres from the attacker when he/she is doing the throw.

## Other hand signals



### Goal

A legal goal has been scored (the entire ball has completely crossed the goal line) and the referee confirms with two short whistle signals and this hand signal.

2x short



### Illegal dribble

The player with the ball violated the rules of dribbling and the referee confirms with one short whistle signal and this hand signal.

1x short



### Too many steps or holding the ball for more than 3 seconds

The player is permitted to take a maximum of 3 steps with the ball in his/her hands, and to hold the ball for a maximum of 3 seconds after taking his/her steps.

1x short



The referee confirms these rule violations with one short whistle signal and this hand signal.



### Restraining, holding or pushing

The referee confirms this rule violation with one short whistle signal and this hand signal.

Foul committed by defender can result in progressive punishment.

1x short



### Hitting

The referee confirms this rule violation with one short whistle signal and this hand signal.

Foul committed by defender can result in progressive punishment.

1x short



### Offensive foul

The referee confirms this rule violation with one short whistle signal and this hand signal.

Foul committed by attacker results in losing possession of the ball.

1x short





### Keep the distance of 3 metres

Keep the distance of 3 metres during the execution of throws. Then, the throw is executed after one short whistle signal.

1x short



### Forewarning signal

The attacking team executes passive play – they risk losing possession of the ball after 6 passes.



### Passive play

The referee confirms this rule violation with one short whistle signal and this hand signal. The team loses possession of the ball.

1x short



### Time-out

The referee confirms the team time-out with three short whistle signals and this hand signal. One team can have 3 time-outs, but only two in one half and only one in the last 5 minutes of the second half.

3x short

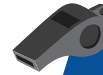

### Leg

When a ball touches a player's leg below the knee, the referee confirms this rule violation with one short whistle signal. Team loses possession of the ball.

1x short



## Progressive punishment

Progressive punishment is given to the players who do not follow the rules of 'fair play' or violate the rules in any other way. The referee whistles once and then shows one of the following hand signals:



### Warning

*Yellow card:* only one per player, a maximum of three per team.

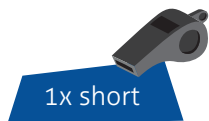

### Disqualification

*Red card:* the player is suspended for the rest of the match, the team continues in numerical inferiority for 2 minutes.

### Information written report

*Blue card:* can be given after a red card and can lead to consequences for the player for the next competition.



### Suspension

For 2 minutes, the team has to continue in numerical inferiority.

The referee stops the time with three short whistle signals and this hand signal.

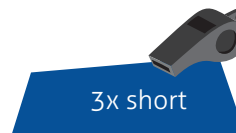

In situations requiring disqualification and suspensions, the referee must stop the time with three short whistle signals.

**Note:** Referees can whistle, stop the game and explain to the players what is not according to the rules without any punishment. From an educational point of view for beginners, the coach can substitute the player and the team will not play in numerical inferiority.

### Remarks:

Rules can be adjusted according to the level of the children or by the kind of facilities.

For more information about mini handball or handball rules and refereeing please go to [www.ihf.info](http://www.ihf.info).

## 4.5 Handball Equipment

For all types of handball, it is necessary to use specific equipment. Parameters such as dimensions and weight of equipment are determined by official rules. For learning and training, we can use alternative materials, which is even recommended for a more fun and often more effective learning process.

### GOAL

A goal is placed in the centre of each goal line.

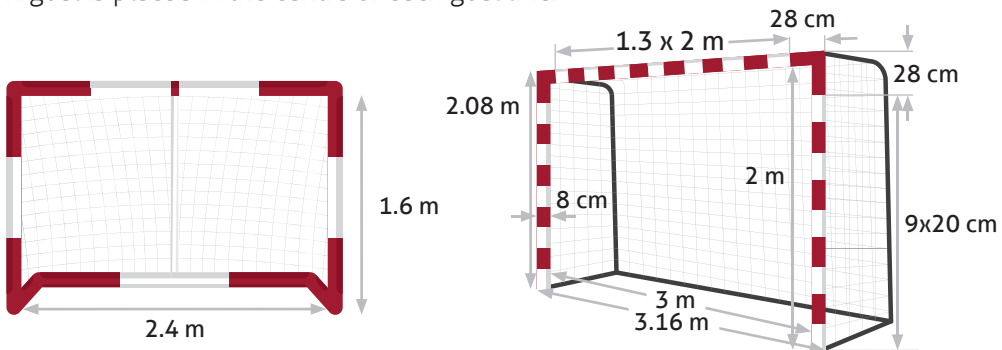

Mini handball goals have a height of 1.6 metres and a width of 2.4 metres.

Handball goals have an interior height of 2 metres and a width of 3 metres. These goal posts must be firmly attached to the floor or to the walls behind them.

### There are many alternatives to adapt and create a goal:

- ↳ Wooden, iron or plastic goal.
- ↳ Reduction of regular goal by board or plastic sheeting.
- ↳ Inflatable portable goal from beach handball.
- ↳ PVC pipe goal (see the picture below).
- ↳ Goal painted on the wall.
- ↳ Various tools: mats, box, brooms, rope, trees, etc.
- ↳ Alternative goals such as bench, cone, circle, wrapped sticks, etc.

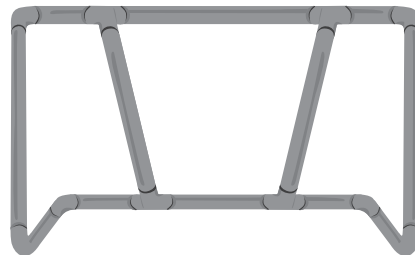
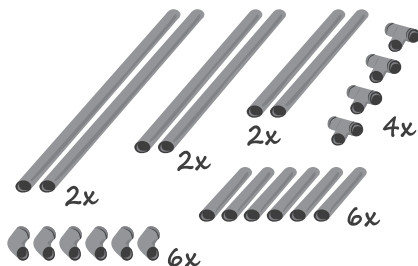

## BALL

For mini handball and handball we use these four sizes:

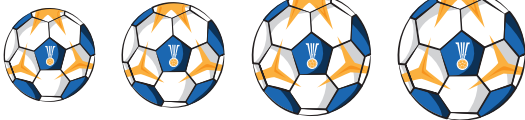

Size 0

Size 1

Size 2

Size 3

**Mini handball**

**Handball**

**Size 0:** 46-48 cm, 225-275 g; for women's and men's youth under 8/10y (for mini handball or for beginners).

**Size 1:** 50-52 cm, 290-330 g; for women's (8-14y) and men's (8-12y) youth.

**Size 2:** 54-56 cm, 325-375 g; for women's (14y and older) and men's (12-16y) youth.

**Size 3:** 58-60 cm, 425-475 g; for men's (16y and older) youth and men.

For beginners, the ball can be smaller than those specified for the particular age of the players, and making use of many different balls is key to player development, as it improves coordination skills and feel for the ball.

To produce an **alternative ball**, we need a plastic bag (sock), a filler (paper, cloth, foam, styrofoam, or something soft and light) and adhesive tape.



**Small-sided games** can be played with many different balls or objects made from diverse materials, but for beginners, the most suitable are soft, not too heavy, easy to grasp and colourful balls (e.g., squeeze-ball).





## UNIFORM

In mini handball, the goalkeepers are not obliged to wear a uniform that is different from those of the field players as explained on page 22.

In handball, all players used in the goalkeeper position on a team must wear the same colour, a colour that distinguishes them from the court players of both teams, the goalkeepers of the opposing team and referees.

On each uniform must be visible jersey numbers that are at least 20 cm high in the back of the shirt and at least 10 cm in the front. Shoes are part of the equipment.

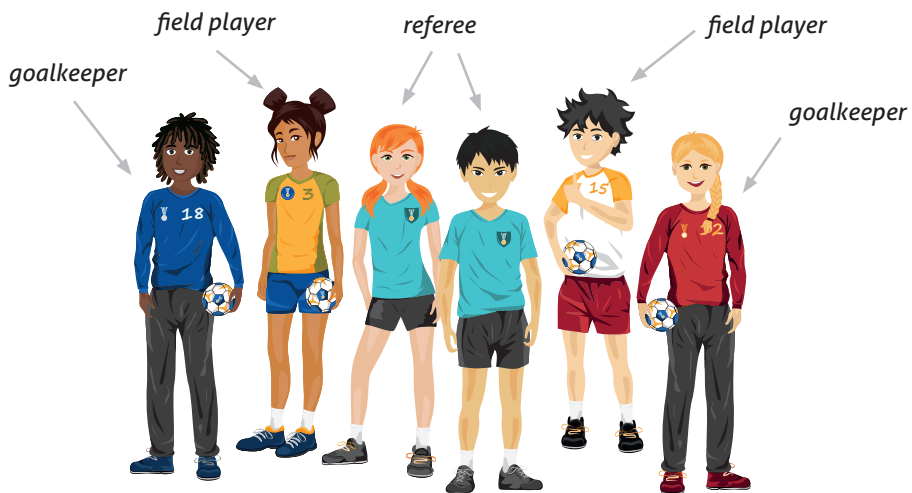

**For dividing the players during game play, when they do not have a uniform, we can use:**

- ↪ Distinctive jersey, colourful training shirts.
- ↪ Collapsed sleeves, knot in the t-shirt.
- ↪ Coloured ribbon, adhesive tape, etc.

**Note:** It is not permitted to wear objects that could be dangerous to the players or give players improper advantages (e.g., gloves, watches, rings, piercing, necklaces, etc.).

## TRAINING EQUIPMENT

Small-sided games, as well as exercises to develop skills and abilities of children with equipment (cones, ladder, obstacles, hoops, etc.) can be more fun and promote efficacy during the learning process. Here are a few basic ideas:

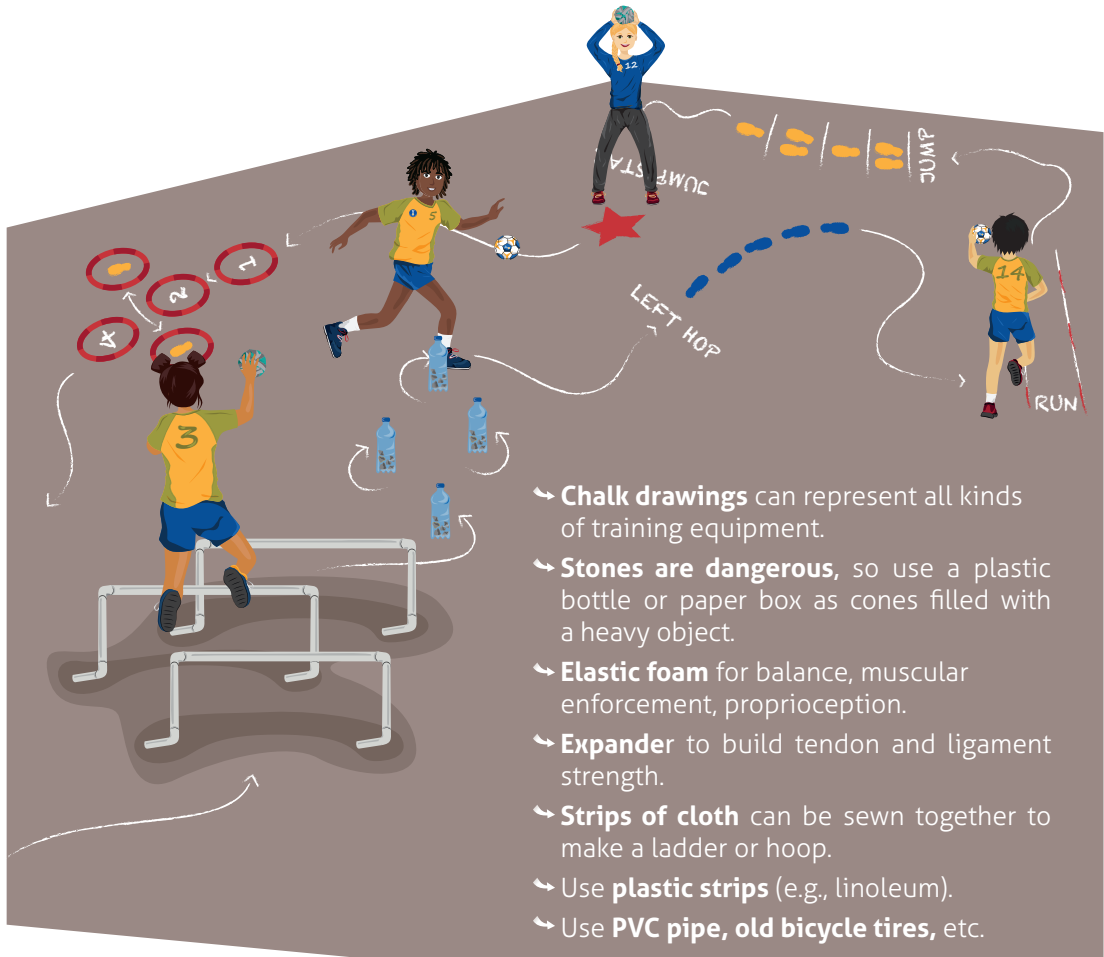

### Remarks:

The creativity and ingenuity of PE teachers and coaches is without limit. Therefore, we hope that these basic ideas will inspire you to work with children and create other handball tools for your training sessions.



**School handball programmes** have the potential to develop and broaden the foundation of 'Learning by Doing' that takes place in physical education classes at schools around the world. Therefore, the IHF provides the opportunity to introduce a comprehensive training and education programme for PE teachers and coaches in schools across all continents.

The focus of our mission will be to support the delivery of handball curriculum activities, such as school lessons, and to provide organisational tools that support the formation of festivals, tournaments and leagues. It is important to note that handball in schools is primarily a collective activity, based on fundamental movements such as running, jumping, catching and throwing and understanding the basic principles of the game. Also, it is anticipated that the training of PE teachers/coaches and national/continental multipliers will lead to a natural growth in the provision of handball curriculum-based activities.

### The underlying philosophical principles of this programme include:

- ↳ **Learning** step-by-step.
- ↳ **Respect** the developmental stages of children.
- ↳ **Develop** positive experiences in physical education:
  - Pursuant to health and fitness standards.
  - According to fair play, team spirit, friendship, and healthy lifestyle.
- ↳ **Teaching** students the right values and the importance of individual and group development, being able to analyse situations and to quickly choose correct solutions with respect to rules, understanding of team roles, support and cohesion with teammates, etc.
- ↳ **Gain** personal experience of success, failure, cooperation, responsibility, confidence, etc. through playing handball.
- ↳ **Emphasis** on enjoyment, motivation, participation, integration, inclusion, equality, intelligence, communication, creativity, etc.

The Handball at School programme has several core objectives, including making handball more attractive to youngsters through a game-based approach. For successful implementation and subsequent development of this programme, the IHF helps with the creation of new methodical materials and specialised courses for the whole education system, which includes students, PE teachers, multipliers, lecturers, coaches, college and university sports development staff, etc. We believe this programme can greatly contribute to the physical, social and intellectual development of children, as well as promote physical literacy for communities.

## PHYSICAL LITERACY

H@S programme is the...

The future of our sport is in the hands of children. Therefore, we must motivate them to be active, give them the opportunity to gain confidence, help them develop physical fitness and healthfulness, and promote the right values for life.



... to be  
**ACTIVE FOR LIFE**

As always, our main goal remains to introduce this programme to decision-makers, because without the national body's support, and the relevant educational administration's involvement, it will be impossible to make handball an essential part of the PE curriculum.

We are aware that many countries have already been working very intensively and for a long time in this area. Each Ministry of Education and Physical Activity should therefore develop its own strategies in setting activities for children. The specific requirements in individual countries may differ, but so do the possibilities of what can be offered to children with respect to handball. Let us not forget that finding time for the youngest members of our handball family will one day reap great rewards.

***The methods of this Handball at School programme are for children to practice in such a way that inspires them to see, feel, understand and enjoy the sport of handball, and discover new possibilities for physical expression.*** It is our hope that handball can provide students with a solid foundation for a healthy lifestyle and a means to find their place in society. If students want to continue their handball development, they can seek out more engaging activities with school teams or clubs.

***Our booklet series, 'Teaching Handball', and its first volume, 'Teacher Guidelines', should be considered the first step toward finding an effective and practical way to do this!***

## 6. METHODOLOGY AND APPROACH OF TEACHING HANDBALL



Handball is a team game, so it plays an important role in education. Players learn to cooperate with each other. A game must be tough, but in accordance with the rules of fair play, teamwork and a sportsmanlike conduct. These positive aspects and forms of conduct result in socially acceptable behaviour in everyday life. This is the vital, educational aspect of playing handball at school. A very important factor is the improvement of the physical condition of children, which is a very challenging task for PE teachers in today's age of computers, allergies, illnesses, and having only few weekly lessons of physical education classes.



We distinguish five main levels of students in the handball teaching process, and the Handball at School programme primarily develops across the first three levels: novice, beginner and intermediate - and marginally touches the advanced level.

The approach and knowledge of the PE teacher or coach is of utmost importance, because handball is a multifactorial sport, and it is not easy for the PE teacher to concentrate on all skills together, as shown in the following diagram:

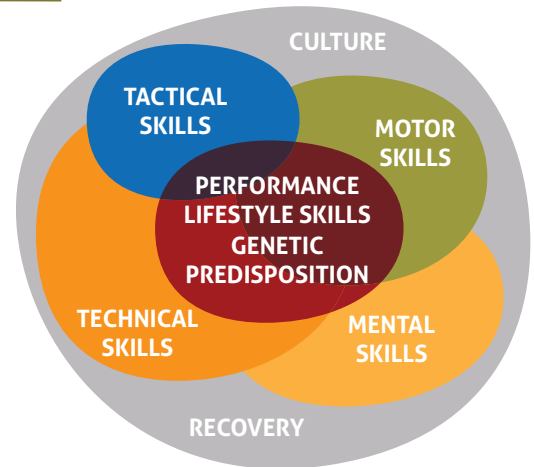

*Key components for skillful play*

### MOTOR SKILLS

Motor skills development is important for all sports. PE teachers should include general motor skills development into the practice of handball, especially when introducing and teaching handball to young students. These foundations include agility, speed, strength, power, coordination, balance, suppleness (flexibility), endurance, etc. This acquisition is not only based on physical, psychological, and biological development, but also the chronological, biological and sporting age of the child.

These motor skills are trainable across the lifespan, but improve at a greater pace if the proper workouts are applied during the right periods of child development. These periods are referred to as the optimal windows of trainability (sensitive period):

### FEMALES

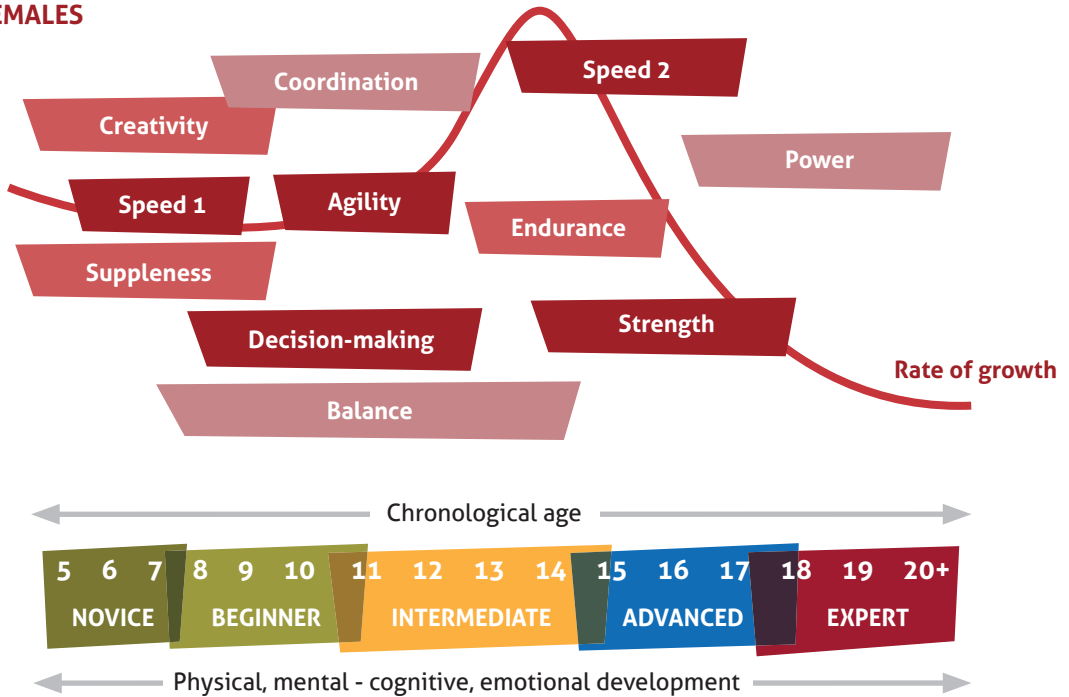

### MALES

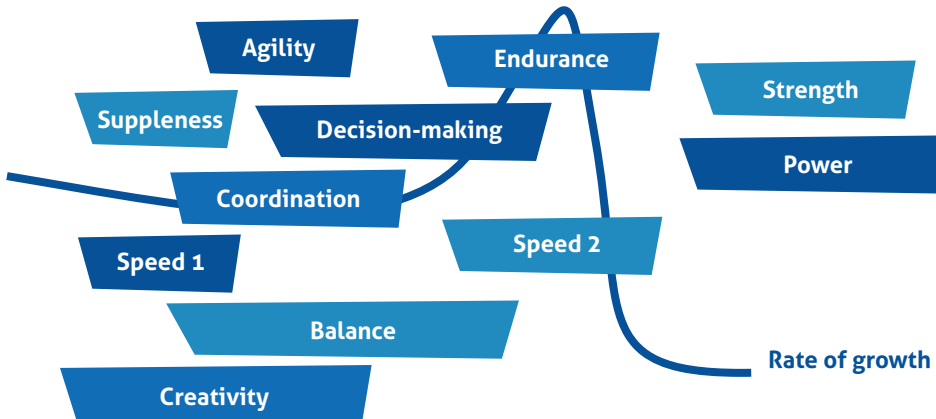

*Key phases of motor and playing skills development*



*Development of body alignment, coordination and balance*

Proper body alignment while moving can help prevent repetitive and excessive load on joints, muscles and spine, alleviating pain and reducing the likelihood of injury. Good posture is essential for good health. As a bonus, correct posture can boost kids' confidence and mood.

In pre-school and school age, emphasis is placed on body alignment, coordination, balance and dissociation of movements, because it is an important basis for complete movements as well as for the prevention of soft tissue injuries in the future (muscles, ligaments, especially major joints such as ankles, knees and shoulders). Based on a good foundation of these skills, players gain greater certainty and accuracy of movement, to which the next development of movement learning is related.

**Note:** Nowadays, the main problem is the lack of physical and spatial body awareness. For this reason, the precondition for the development of motor function is that children are exposed to as many variability experiences as possible. Children are not born with the skills of catching, jumping, throwing, etc. These skills have to be learned. However, children are born with the underlying factors that allow them to perform and develop those tasks.

### Factors affecting skill development:

- ↪ Incorrect understanding of movement (lack of technique, player level, etc.).
- ↪ Poor motor skills (insufficient skills to perform the task).
- ↪ Poor coordination of movement (lacking dissociation of right/left or upper/lower parts).
- ↪ Incorrect application of power (estimation of distance, speed of teammate, etc.).
- ↪ Lack of concentration (very simple/difficult tasks, fatigue, etc.).
- ↪ External factor (e.g., weather).
- ↪ Children are unable to learn complex skills inappropriate for their age on their own.

### To be the best PE teacher/coach of handball, you need to be good in these three domains:

- 1. Know yourself** – know your personality, approach, methods, weaknesses, strengths, lifestyle, culture, ability to cope under pressure, mentality, where you go for help, who you ask for help, etc.
- 2. Know your public** – know your group, class, team, their environment, attitude, interaction, their leader, capacity, personality, mentality, etc.
- 3. Know your sport 'handball'** – know its rules, organisations, methods, strategies, tactics, specific skills required at each phase of development of young players, new trends, injury prevention, recovery, etc.

## 6.1 Learning by Doing Methodology

Each child that comes into the sports place is unique and has a different way of taking in new information and/or ideas. As a PE teachers or coaches works with beginning athletes, it is important that they are able to recognise their level of play.

'**Learning by doing**' is an instructional methodology based on the concept that ideal learning occurs through experiences. Learning tasks require the active participation of children. Additionally, it combines active learning with concrete experience, and engages all learning styles (visual, aural, read/write and kinesthetics).

Children practice and reinforce their learning in multiple areas during game play. It gives them a place and a time for learning that cannot be achieved through simple explanation, observation or by performing only drills. During the 'learning by doing' process, the player improves and develops several skills and abilities at once. The first step is to ensure the creation of a relationship to the physical activity and involvement of all children.

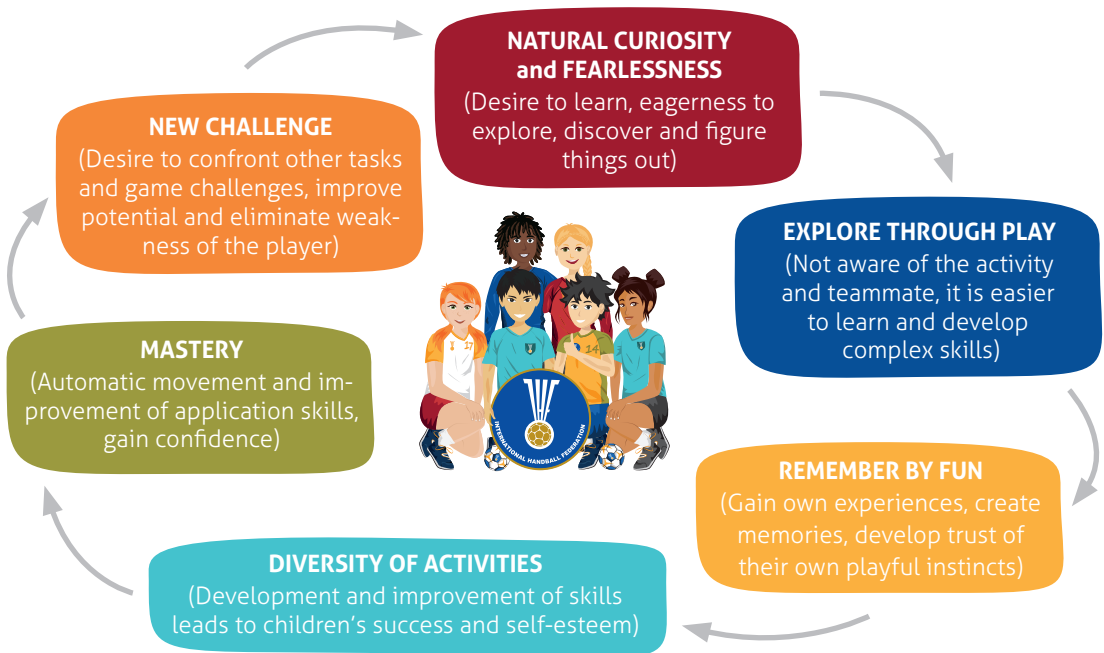

*Children's development learning through play*



## Effective teaching should:

- ↪ Make handball enjoyable and fun to learn.
- ↪ Enhance competence by teams and individuals.
- ↪ Teach understanding of rules and strategies of handball.
- ↪ Provide challenges tailored to children's developmental level and playing skills.
- ↪ Provide opportunities for achievement for each child.
- ↪ Trigger tactical and technical reasoning and creativity.
- ↪ Develop coordination and basic motor skills.
- ↪ Trigger individual self-esteem and self-confidence.
- ↪ Encourage teamwork, good sportsmanship and respect for everyone.
- ↪ Help learners develop a healthy lifestyle.
- ↪ Develop and spread loyal and constructive behaviours.
- ↪ Teach appreciation of the customs and traditions of handball in your country.

The most challenging teaching task for each PE teacher or coach is finding adequate responses to four fundamental questions:

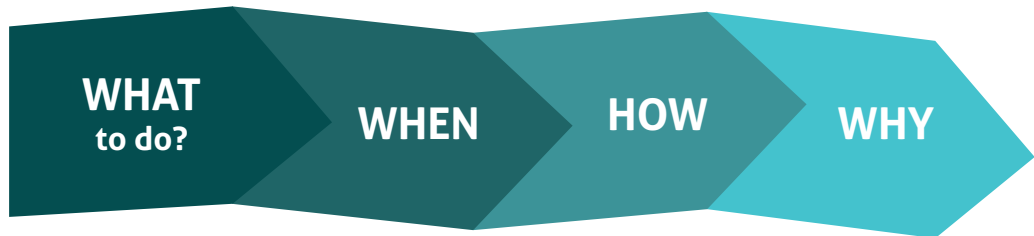

## 6.2 Handball Game-Based Approach

Students desire to play 'real' handball, to play on a team or with a group, to be successful, and to have fun. However, PE teachers often refrain from letting them play or compete, making the lessons look more like work, e.g., repetitive passing-receiving drills while standing still and without opposition. The technique-oriented approach is broadly used to teach handball. These practices are typically boring and not very effective for game understanding and skillful play development. Therefore, in the last decades, new ideas and theoretical insights have come up. The so-called game-based approach (also known as game-centered approach) became widely recommended to enhance effective learning of handball.

The idea of the **game-based approach** is to develop a teaching process with the learner at its centre in problem-solving situations that teach the game of handball. In contrast to the traditional approaches, this approach first emphasises game understanding, appreciation, and learning to solve the problems that arise in the game, and then teaches how to do it. In this approach, the educator is challenged to identify and to prioritise the tactical game problems and skills to be focused on, setting up appropriate learning tasks to improve learners' playing competence.

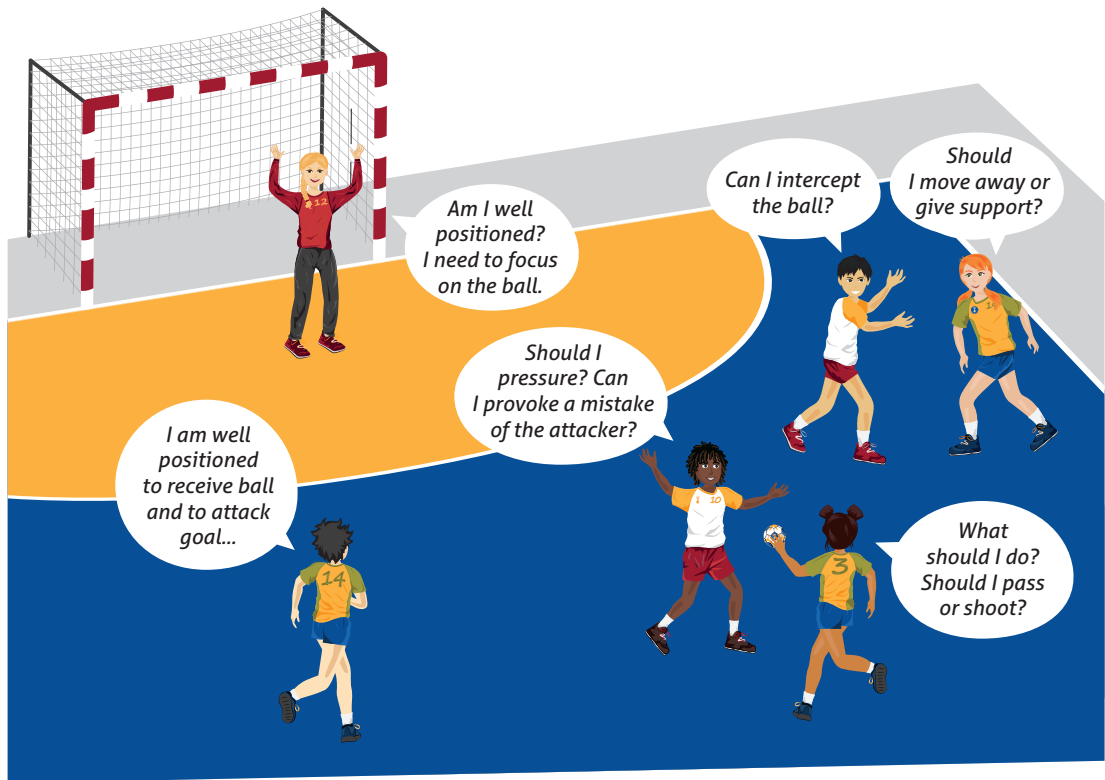

*Game play situation where learners become aware of how to solve 3v2 situation*

The introductory lesson starts with fun lead-up games and with game play. By simplifying and calibrating the tactical complexity and motor-technical demands of the game play, we allow beginners to start playing a basic game form of handball as soon as possible, ensuring early success and exposing children to the core decision-making problems of handball.

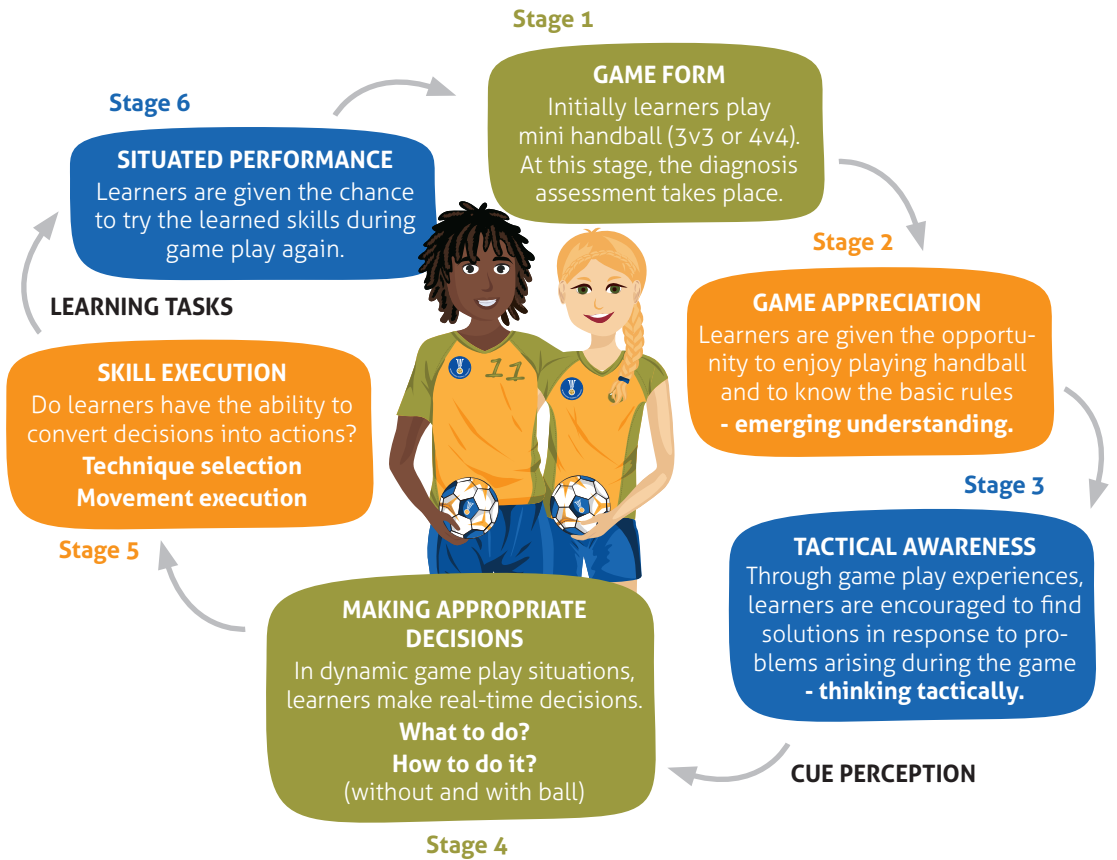

*Major stages for handball learning, based on Teaching Games for Understanding Model*

Effective handball teaching is about combining the teaching of tactical understanding with skill development. On the surface, it makes sense, first, to teach basic handball techniques (throwing and catching, three-step rule, shooting, etc.), and, then, to teach tactics. This might be the case when working with very young learners (under 5-6 years old) that are not able to throw and catch the ball yet, in which case, they should mainly play lead-up games and develop coordination and techniques of ball manipulation, catching and throwing, etc.

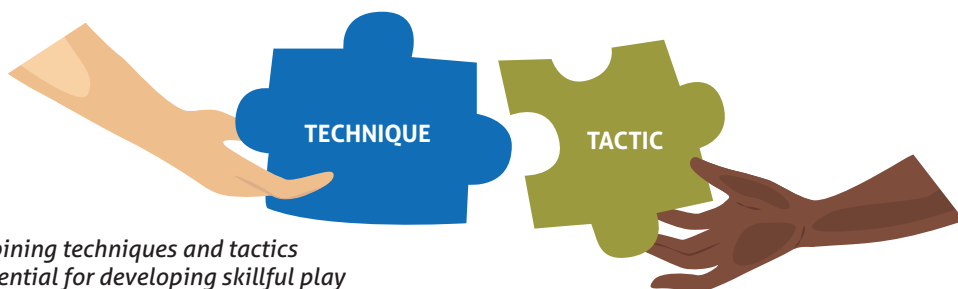

*Combining techniques and tactics is essential for developing skillful play*

The handball game-based approach is a guided discovery method that empowers learners to solve the problems that arise while playing handball. If they have good tactical understanding and the freedom to take risks and to be creative, even with a low level of technique, they will be totally engaged, absorbed and leave the session satisfied, wanting to come back for the next lesson to learn more handball.

To understand why we chose this approach, and why it is so important in the learning process of tactical skills, you need to know what we develop primarily by games and by exercises and drills, because only a good balance between approaches permits adequate development of technical and tactical skills of players. Children need to have a wide gamut of skills, great analysis of the situation, enough experience in the game situation, good physical condition, handball skills, etc.

#### **Small-sided games/game-like tasks:**

- High activity
- Changing conditions
- ↑ Decision-making process
- ↑ Adaptive technique and diversity
- ↑ Group performance
- ↑ High inter-trial variability
- Complete teaching of the game
- Creation of space
- Creativity of solution
- Situated skill development
- Multi-tasking

#### **Technique-oriented approach/drills:**

- Small/high activity
- Stable conditions
- ↓ Decision-making process
- ↑ Refined stiff technique
- ↑ Individual performance
- ↑ High inter-trial consistency
- Teaching of sub-element of the game
- Determined space
- Predetermined
- Skills learned in isolated situation
- Single task

#### **Remarks:**

**Situated skill development drills** refers to tasks designed to learn or to refine a technique or movement in a more game-like situation.

**Lead-up games and activities** start an event or prepare the way for the next level of games (e.g., small-sided games, PGF, BGF), and include catching games, relay games, games based on dodgeball or combo games, for example.

**Small-sided games** is a generic designation for games with few players competing on a smaller sized field, without needing to have all the main handball structuring game play elements (e.g., a goal). It can be a 3v3 passing game, for example.

**Partial Game Forms (PGF)** are game play situations, but simpler than the basic game form, maintaining the handball game dynamics (cooperation versus opposition). By using PGF (also termed game-related tasks), we can manipulate playing constraints to address a specific game problem (e.g., 2v2, in half court with supporters at the wings).

**Basic Game Forms (BGF)** are modified versions of the full handball game (7-a-side), but still maintain their unique traits of cooperative and oppositional relationships. The modifications might include changes to the rules that involve number of players, court and goal size, goal area format, ball's characteristics, defensive constraints and alternative equipment. Through games modifications, tactical and performance complexity of the full game might be reduced or shaped according to teaching needs. Mini handball is a good example of a modified game form.

## 6.3 Implementing Handball Game-Based Approach

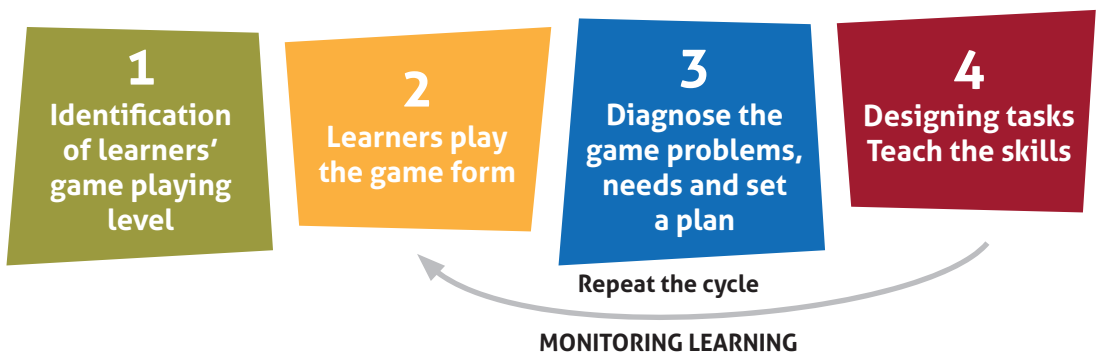

*Major steps for implementing the handball game-based approach*

### STEP 1:

**Identification of learners' game playing level and readiness to meet a certain level of play complexity – *get started with handball***

Before starting, consider what you know about the learners (e.g., age, interests, attitude, motor skills, prior experiences with team sports and handball).

- ↪ **With novices** it is almost certain that they are in the first learning stage, therefore introduce them to the simplest game form (a game with uneven numbers, 4v3+GK, 3v2+GK or 3v1+GK, etc.).

- 
- **With more experienced learners**, we suggest starting playing an even-sided game, such as 3v3 (plus goalkeepers), on a small-sized court, half court or full court (depending on school conditions), with close defensive pressure (also termed individual marking). The purpose behind this strategy is to introduce learners to a game play situation that simulates the dynamics of real handball and ensures better game play with more time with the ball for all the players. At the same time, it is simpler for the educator to get an idea of players' knowledge and playing competences.

Allow learners to play freely and avoid interfering, unless major problems arise, such as dangerous behaviour or systematic goal area violations, among others. As they play, your roles are observing, analysing how well they are able to solve key game problems, encouraging them and giving them very simple advice. A framework for deciding and shaping the game format according to learners' level of competence is presented further ahead.

### ***How to decide which modified game form to address first***

Start to assess the overall game play quality, flow of play and major game problems based on the principles of the game:

- Are players having troubles with retaining ball possession?
- Are players working together in advancing the ball towards goal?
- Are players setting up open scoring opportunities? Are they scoring when they are unopposed or opposed?
- Are players able to prevent scoring by opponents?

### **Example:**

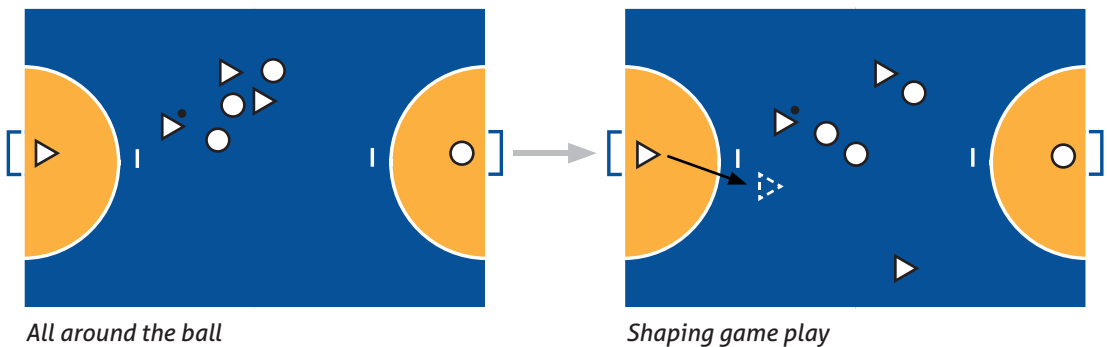

When introducing handball to novices, players gathering around the ball is frequent. This usually results in losing the ball without any scoring attempt being made. By using offensive numerical advantage (4v3+GK), where the goalkeeper joins the attack, we are modifying and tailoring the playing constraints.

## FRAMEWORKS FOR DIAGNOSING LEVEL OF GAME PERFORMANCE

MAJOR GAME PROBLEMS	SHAPING GAME PLAY SETTINGS
<p>Players are <b>not able to maintain ball possession</b> and when making <b>forward progression</b> to attack goal against <b>defensive pressure</b> they never/rarely reach goal.</p>	<p><b>NOVICE LEVEL</b> (mini handball – <b>unstructured defence</b>)</p> <p>Choose a game form based on offensive numerical advantage, namely 3+GK vs 3+GK, where the goalkeeper joins the attack creating outnumbered play (4v3+GK).</p>
<p>Players are able to maintain ball possession when facing defensive pressure, but still <b>struggle getting unmarked without the ball</b> and <b>beating defender with ball in wide-open spaces</b>.</p>	<p><b>BEGINNER LEVEL</b> (mini handball – <b>individual defensive responsibility</b>)</p> <p>Use a game form 3+GK vs 3+GK and then 4+GK vs 4+GK with full-court pressure (individual defensive responsibility), emphasising fast transition offence and game play without the ball.</p>
<p><b>Defenders are not able to keep full-court pressure</b>, as a cause of attacking play improvement, enabling opponents easy ball progression and setting up good scoring opportunities in the small/medium-sized court.</p>	<p><b>INTERMEDIATE LEVEL</b> (transition to handball – <b>positional responsibility</b>)</p> <p>Use a game form 4+GK vs 4+GK with a zone pressure defence (2:2), focusing on break-through actions (duels with ball) and wide attacking play.</p>
<p><b>Attackers are able to easily set up a scoring opportunity when facing a zone pressure defence (2:2), within a smaller/medium-sized court</b>, due to skills play improvement and physical development (as a consequence of normal growth and development around puberty).</p>	<p><b>INTERMEDIATE/ADVANCED LEVEL</b> (handball – <b>full game</b>)</p> <p>Introduce a more complex game form on an official court size with the game form 5+GK vs 5+GK without the pivot and then with the pivot. Thereafter, we can start with the game form 6+GK vs 6+GK. If the official court size is not available, we need to reduce number of players.</p>

### STEP 2:

#### Learners play the selected modified game form: teaching through the game and in the game

Only when children recognise the game problems are they encouraged to find and try appropriate strategies. Consequently, they are really engaged with effective and meaningful learning.

However, the ability to read the situational constraints and to deliberately explore proper

---

game play solutions do not necessarily develop easily, especially with unskillful or novice players; they need to be explicitly taught in a way that can be transferred across several game play situations. If learners have troubles solving the game problems because of a lack of tactical awareness, the PE teacher/coach should help them discover what to do in order to play successfully, using more guided discovery and questions than direct methods. Asking the right questions at the right time is an important instructional skill.

While they are playing, try to **freeze** and **scan** a critical playing situation (representing the big picture of the problem), and to ask questions about the mistakes that you are seeing. Try to drive the learners' focus onto the game's principles and what they should do to reach the goal (e.g., looking to pass the ball to a free teammate, move away from the ball handler and toward an empty space ahead). Here, it is useful to slowly demonstrate how to solve the problem (paint a clear picture of what they are supposed to do). Afterward, let them play again, and observe if there were improvements in their tactical awareness and execution. If needed, modify or shape the game play constraints, bearing in mind to improve game involvement, appreciation and understanding.

A clear understanding of the main tactical game principles (attack and defence) and tactical and technical behaviour should provide the teacher with a starting point to evaluate the beginner's playing performance. Additionally, failing to realise the effect of certain key playing constraints (e.g., number of players, space, defensive organisation, rules) on the novices' game can cause the teacher difficulties to clearly prioritise the game problems and teaching content to work on during lessons.

### STEP 3:

#### **Diagnose the main playing problems and difficulties; establish what they need to learn next**

Game play is a unique source of experience, knowledge and game sense for both learners and educators. Learners develop their game appreciation and tactical awareness while experiencing enjoyment and fun. For educators, these game-playing situations are the roots of pedagogic content knowledge, as they allow noting the game problems that the learners are not able to solve and to understand their causes. As the major problems always arise from minor problems, namely, relational and individual problems, it is the ultimate goal to clearly identify them when it comes to setting up teaching priorities. This judgment is essential when establishing the objectives for the unit plan or lesson plan and designing effective learning tasks.

With beginners, it is easier to determine what needs to be improved. However, when working with challenging groups of adolescents and more experienced players, this might be a complex task, demanding considerable analysis and critical thinking.



## PROBLEM-DIAGNOSIS FRAMEWORK

Are learners able to keep possession of the ball under pressure? If not, is it because they have any of these problems?

### Attacker with the ball

- **Lack of game reading and decision-making skills** (is unaware of open receivers and of how to adjust time and pass type to playing constraints).
- **Deficit of motor and technical skills** (improper one-hand throwing technique, especially on the run).

### Attacker without the ball

- **Is unaware of spacing positioning and when and how to move into open space to get open**, when being unopposed or opposed.
- **Is unaware of a teammate's pass** and does not catch ball successfully most of the time.
- **Lack of motor skills to beat opponent**, by using timely fakes to get open.

Are they able to cooperate to make forward progression when being opposed? If not, is it because they have any of these problems?

### Attacker with the ball

- **Struggles in reading the play and making proper decisions under pressure** (to pass away from pressure, to give-and-go, to play one-on-one, or to dribble) for fast ball progression.
- **Is unable to make accurate lead passes.**
- **Deficit of sequencing motor tasks** (receiving, dribbling, passing/shooting).

### Attacker without the ball

- **Is unaware of when and how to evade defender to get open to attack goal**, by timely employing faking/cutting moves.
- **Is unaware of when to create space** (by drawing out defender) **or to get open to support ball possessor** (approaches him/her).

Are they able to set up an open scoring opportunity and to take advantage of numerical superiority? If not, is it because they have any of these problems?

### Attacker with the Ball

- **Is unaware of an opening and hesitates or does not take an open shot.**
- **Improper shooting technique** (does not form the throwing technique correctly, e.g., elbow below shoulder height).
- **Deficit of coordination skills** (difficulties in integrating independent movements with various body segments).

### Attacker without the Ball

- **Is unaware of outnumbered situation** and what to do to take advantage of it, by moving away (makes space for teammates) or running forward to receive and to shoot.

Are players able to prevent scoring by opponents? If not, is it because they have any of these problems?

### Defender

- After losing ball possession, **is unaware of fast repositioning**, being placed between ball and goal he/she protects.
- **Is unaware of when to closely mark ball possessor or to close off a passing lane** (e.g., when having open receiver close to goal area).
- **Is unable to anticipate a pass and to act to intercept the ball.**

### STEP 4:

**Decompose the game problems and make clear the tactical solutions or skills you are wishing to address**

When it is evident whether it is tactical, motor, technical weakness or a combination of several factors that are limiting the youngsters' performance, the educator is challenged to design effective learning tasks and activities focusing on their needs.

- **Game-related tasks** (tactical focus) aim at working on a specific game problem while technique is learned in a more adaptive or flexible way. These kind of tasks should be viewed as a way to break down a complex and meaningful game problem into easier problems. The idea is to promote effortless automatic recognition of a problematic playing situation and to guide or to facilitate discovery of the possible solutions we intend to teach. Two against one (2v1) with open space is a common example of a learning situation to work interplay (with and without ball) to create an easy scoring situation and, at the same time, permits the improvement of technical (catching, passing, shooting, etc.) and tactical skills.
- **Skill practice** (technical focus). This type of task can be used if it is clear that learners need to work on motor skills or techniques to improve game play participation. For example, with absolute beginners, it is almost certain they will need to learn receiving/throwing techniques and to develop coordination skills. The **technical freeze** allows the PE teacher to correct a wrong technique (such as shooting), and to use demonstration to address the correct motion.

By manipulating task constraints, we can direct learners to acquire specific movements, skills or game play solutions. Changing task constraints can allow youngsters to learn optimal movement patterns (for example, through the use of a soft ball, players can easily adopt a correct throwing technique) or to compel them to make the best decision when interacting with others, according to situational constraints (e.g., time-space, players involved, etc.).

It is also important that tasks provide immediate inherent feedback to the learner, regarding how well the task is being done, allowing them to use that information in the next attempt or while the process unfolds.



## Design tasks that:

- ↪ Are fun, have goals, competition or challenges.
- ↪ Provide inherent feedback.
- ↪ Are game-like.
- ↪ Permit choice (open skills).
- ↪ Provide variability.
- ↪ Provide multiple chances to make mistakes (learning from it) and to get it right.

Teams and students should be presented with situations just a little above their present competence. This will provide enough challenge without being overwhelming to the learner. Diversity in the situations is of the utmost importance, both as developmental and motivational tools (***repetition without repeating***).

**Remember that positive emotions have a particularly strong influence on attention, memory, reasoning, and problem-solving.** Even a technical task should be challenging, if possible.

## CHANGE IT:

**Coaching style** – use of questions, different signals, incentives, etc.

**How to score/win** – kind of shot, kind of goal, etc.

**Area** – size of court, ground plan (triangle, circle, rectangle, etc.).

**Number of players** – 3-7 in group.

**Game rules** – kind of movement, no dribbling, evolution of situation, etc.

**Equipment** – small ball, lower goal, etc.

**Inclusion** – everyone touches the ball before the team can score, etc.

**Time** – duration of activity, work with 3-second rules (more/less than 3 seconds), etc.

**Note:** Use a game-based approach to teach and develop game sense and handball skills in a fun, meaningful and rewarding environment.

## 6.4 Unit Planning

In daily PE practice, educators are often confronted with short units for planning problems (e.g., a set of 5 or fewer lessons). Time is always scarce for those who are serious about teaching young players to play handball skilfully. Therefore, it is essential to set up the learning priorities and objectives linked with the teaching approach.

A handball unit plan should entail a short description of play-level achievements that might be expected, taking into consideration the learning context (e.g., number of students, availability

and conditions of facilities/equipment for handball practice, time available) and students characteristics (e.g., age, knowledge, motivation and playing skills, among other aspects).

Given the broad variety of aspects that can condition the teaching process, it would be unrealistic to prescribe a specific unit plan that could address all situations. Nevertheless, scope and sequence of approximately 8 lessons for a class of beginners (about 10-11 years of age) is presented in the appendix.

## PLANNING UNIT GUIDELINES

- Define which game form(s) should be primarily approached and determine what aim might be reached by the end of the process (or through cycles of work).
- It is important to emphasise that, sometimes, more than one game form might be approached depending on teaching context.
- Decide which and when to perform intra-class competition/tournaments.
- Consider the timeline and decide the main functional game units (or structure of learning tasks) to work, breaking down the game problems (see next table).

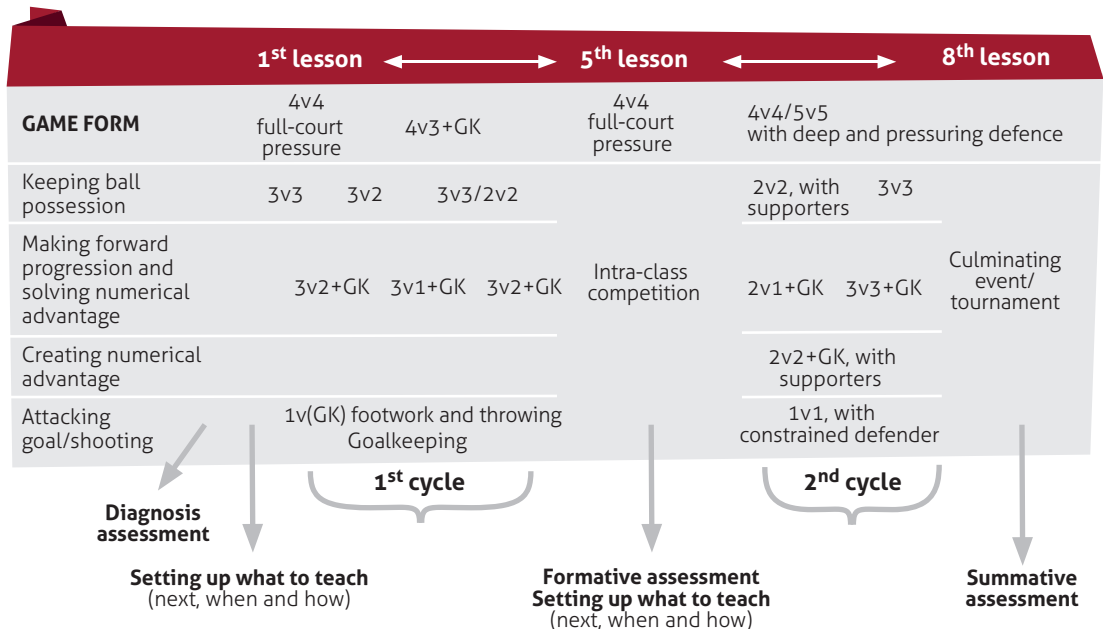

## 6.5 Lesson Planning

Regardless of a certain format that each PE class is used to or schools might require, every effective lesson plan should be designed in order to ensure that the most thoughtful approach is being taken to get students to the desirable playing level and connected to long-term physical educational goals.



The time allocated to handball is precious, so, be aware how you can improve your planning, organisation, and instructional methods/skills.

### **Guidelines for lesson planning**

- ↳ Ensure multiple opportunities for practice, enjoyment and challenge.
- ↳ Use more game/game-like tasks than exercises/drills.
- ↳ Work more with the ball than without the ball.
- ↳ Scaffolding practice from easy to hard and from simple to complex tactical and motor behaviour.
- ↳ Be clear about how a task and activity aligns with the teaching goals.
- ↳ Monitor and correct student performance.

## **STANDARD LESSON STRUCTURE**

### **Before starting**

Be aware of ensuring that the students are prepared both cognitively and physically to meet the demands of the lesson, or whether the lesson is not challenging enough.

With very small kids, it may not make sense to clearly distinguish between opening and developing tasks, as most of the lesson may be based on skill challenging games, such as lead-up or small-sided games.

### **Opening the lesson**

Focus on what they will work on/do and why it is important. Make connections between the game's problems and the main focus of the lesson/learning tasks.

### **Warm-up**

Initiate with a lively, challenging and easy lead-up game. If possible, use a lead-up game that works on skills linked with students' difficulties or lesson themes.

### **Main part (development)**

Include game-playing, using the chosen basic game form at the beginning or at the end. This decision relies on your instructional methods, day of plan unit and objectives, and, sometimes, available facilities. Set up specific play practices based on simplified, shaped games and learning tasks depending on students' age, level of play and game problems you wish to address. If possible, organise a short interclass groups/teams competition.

### **Ending**

Include a motivating and challenging activity for the end of the lesson, then, look for a cool-down period, where you may question the students about the lesson, about what they enjoyed most, what they learned, among other aspects linked with the lesson's targets and main observed difficulties.

**Note:** A standard lesson form can be found in the appendix.

**Remarks:**

The main problem for many PE teachers is too many students in too small of a space or without a handball court. Our programme is flexible with regard to the training area. We can divide space as needed for training:

*Educators should avoid having queues of children waiting for their turn.*

*It will be advantageous to use any flat space to carry out various tactical games, exercises and different tasks in small groups.*

**WRONG! Too little activity**



**RIGHT! A lot of activity**



**Other ideas for dividing the workspace:**

*More rectangle fields*



*More playing ground crosswise*



*Games on the court, drills on the side*



**Practice advice:**

Please take note of the following safety information when playing and exercising in different fields placed side-by-side:

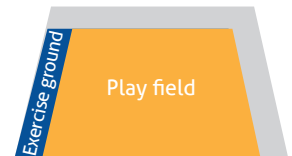

- Using ball boxes or the like to prevent balls from rolling into other fields.
- Cones, nets or other equipment, e.g., mats or barrier tape, may be used as a space divider, but do not use bars and benches (as these are dangerous).

## 7. BASIC COLLECTIVE PLAY



In this chapter, we explain basic game principles and elements that you need for understanding handball. In game play, there are different levels of tactical organisation given the number of players involved.

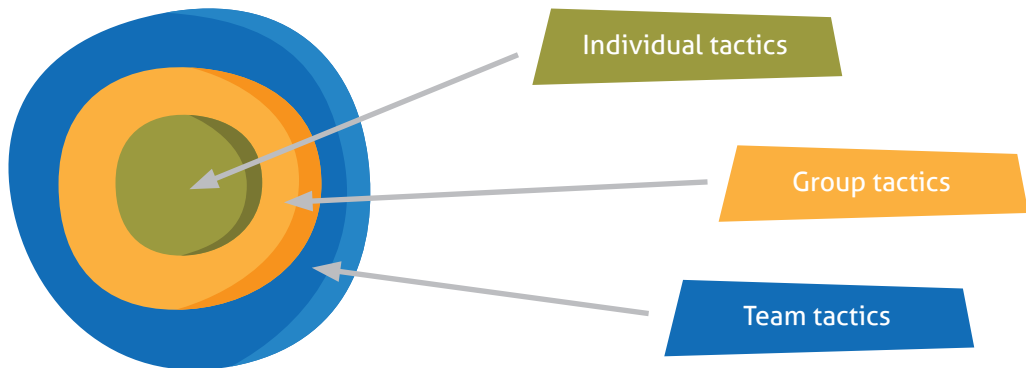

*Different levels of tactical game play construction*

The **individual-tactical skills** represent the player's ability to generate actions, taking into account situational variables and applicable action rules or principles.

The **group-tactical actions** are joint actions between two or more players, who cooperate to solve situational game problems. Therefore, the group-tactical elements (e.g., give-and-go) are a kind of standardised pattern of action between players.

From a team-tactical perspective, the **system of play** provides the basis for team organisation and also the concrete basis for players to act and interact in a logical and interconnected way. Therefore, joint and individual actions should always be submitted to the basic tactical organisation of the team and game principles.

Depending on the playing context, the game play might occur with **numerical equality** (for example, 4 against 4 or 6 against 6), **numerical advantage** (for example, 6 against 5 or 7 against 6), **numerical disadvantage** (for example, 5 against 6) and with wide open or narrow space. Therefore, the situational constraints (number of players, distance from goal and space) may lead to distinct possibilities of game play: transition (to attack and to defence) or positional play (attack or defence).

## 7.1 Attack

The attacking phase formally begins when a team takes possession of the ball, but distinction has to be made between fast break, or making forward progression with open/wide space (also termed transition play from defence to attack), and game play around the goal area with narrow space (also termed positional build-up attack).

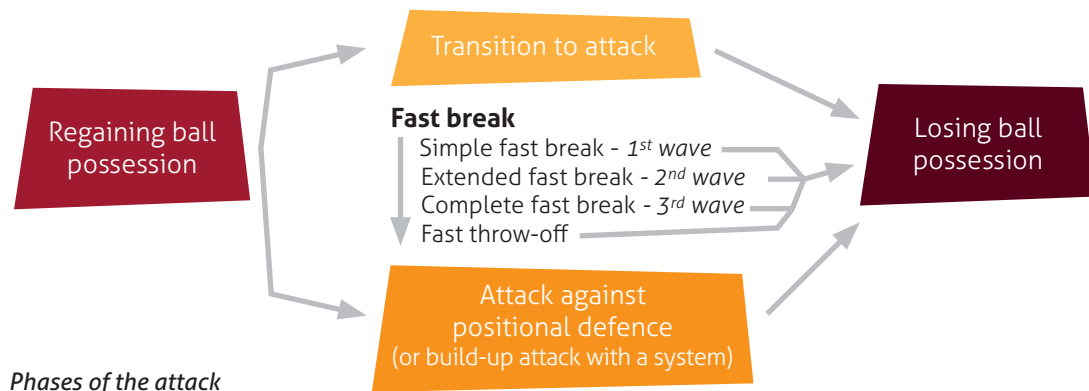

### TRANSITION TO ATTACK

The primary goal of all attacking attempts is the creation of an open scoring opportunity into spaces of great value. Therefore, as a basic principle, once a team has gained possession of the ball, the most important thing is to evaluate if there is advantage (positional, temporal-spatial and/or numerical) to fast attack the opponent's goal, so that the defence does not have time to set up.

In handball, a fast break is often the result of good defensive play (such as an interception, stealing the ball while dribbling, forced technical error, blocked or provoked missed shot or offensive foul) and immediate readiness to counterattack quickly. However, even after having conceded a goal (fast throw-off) a fast break attack might also follow.

### Teaching the basics of fast break and tactical structure

It must be made clear that the fast break is the best and simplest way to get easy scoring opportunities in handball. So, when gaining possession of the ball, the fast break is the primary offensive option, and the quicker a team's tactical transition to fast break, the better the chances they will take advantage of the time during which the opposing team is still retreating and reorganising.

There is a wide range of game play situations where it is appropriate to employ fast breaking (1vGK, 2v1+GK, 3v1+GK, 3v2+GK, 4v2+GK, etc.). However, the effectiveness of fast counter-



attacks always depends on the players' concentration, fast reaction and decision-making after regaining possession (e.g., fast breaking culture).

### Basic team tactical structure and key tactical roles to learn:

- ↪ **Forward line fast break:** creates danger and goal scoring opportunities by using *self-breaking* or sudden acceleration and running up the court, evading defenders and getting open into spaces of great value to attack goal.
- ↪ **Back line fast break:** makes forward ball progression, by using a direct pass toward the shooter (*direct fast break*) or short/fast progressing passes (*indirect and supported fast break*).

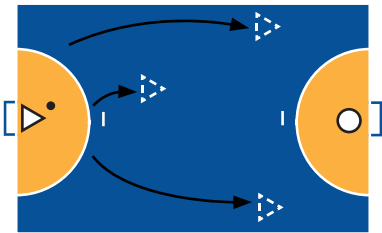

Transitional play in 3+GK - example

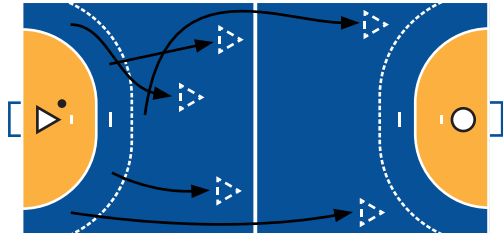

Transitional play in 5+GK - example

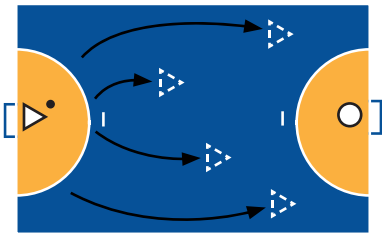

Transitional play in 4+GK - example

### Key principles to teach from the very beginning:

- ↪ Always be ready for fast breaking (without and with ball).
- ↪ Anyone can gain ball possession to initiate a fast break attempt.
- ↪ When the ball is out of play, anyone can put it into play as quickly as possible.
- ↪ If player has an open receiver ahead, pass the ball fast and accurately.
- ↪ If players are without the ball, immediately spread out (in depth and width) to create space and staggered passing lanes for fast forward play.

### New trends in transition phase - fast break:

- ↪ Fast transition to attack (in defence be ready to fast break).
- ↪ Readiness to risk (not be afraid of risky solution).
- ↪ Tempo (adequate acceleration or deceleration as needed: fixation - escape) games at all stages.
- ↪ Continuation of the game without a preparatory (intermediate) phase, continuing the game pressure.
- ↪ Game in tempo with limitation of substitution of specialists (attacker).

## Some terms for advanced levels:

**Simple fast break** occurs when the defending team gets the ball and is able to move quickly up the court, getting an easy scoring attempt, with a minimum of fast inter-passes and players being involved. That's the case when a defender steals a ball and then speed-dribbles the ball up the court and takes the shot him/herself (self-fast break), a player (goalkeeper or a court player) passes ball to an open receiver ahead (e.g., wing) for quick scoring (direct fast break), or two quick passes are executed before shooting (indirect fast break). Others may call it the 1<sup>st</sup> wave or primary fast break.

The **extended fast break** is triggered when more attackers are involved in making fast forward progression with quick inter-passing in an attempt to score before the defensive team can get into position. Also termed 2<sup>nd</sup> wave or secondary fast break.

The **complete fast break** is performed around the goal area when the defending team has already returned, but has not yet adjusted their defensive system. In this way, it is a kind of sustained fast break attack or pressure play aiming to exploit the opponents' temporary defence. Others may call it a fast attack without slowing down the play to organise the attack.

The **fast throw-off** occurs when the team who suffered a goal employs a fast break attack from the middle of the court and the other team has not yet fully returned and/or adjusted.

## ATTACK AGAINST POSITIONAL DEFENCE

A key component of effective building up in the attack is the ability to break through the opponents' defensive structure to create an opening to score. In general, apart from the basic formation, there are two major different approaches for building up attack: **open play** and **set play**.

**Open play** requires literate play, relative freedom, challenging the players to read the play and to find intelligent solutions, which we are pursuing in this approach in all levels of learning. Thus, it is crucial to understand the basic game principles, tactical roles and action rules to cooperate with teammates in an efficient way, taking into consideration the dynamics of the situational constraints. Then, it entails a more adaptive, anticipative, flexible tactical behaviour and versatile technical skills. This approach should not be confused with selfish play.

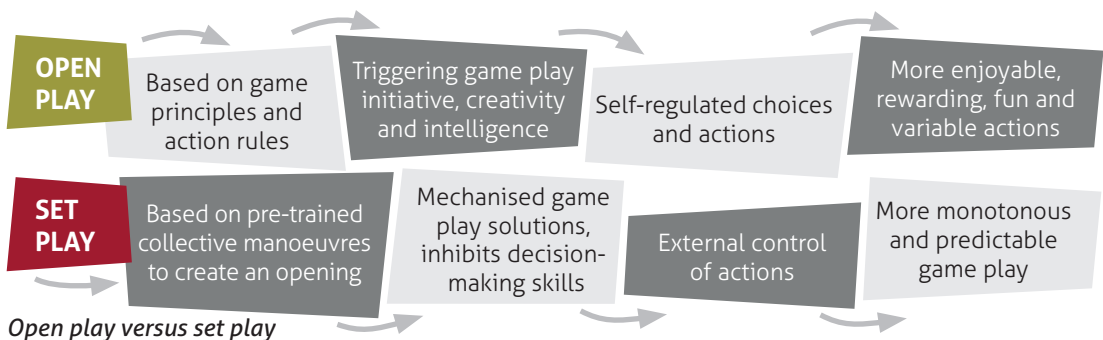

At the advanced/expert levels, build up play with set moves, but not all coaches apply them in a closed way. Therefore, the same collective schemes are built up with several finishing alternatives or continuing moves, according to the changing game responses produced by defenders and the creativity of the attackers.

### New trends in attack:

- ↪ Huge individual player repertoire of techniques (huge gamut of technical skills due to tactical situation) and their fast execution.
- ↪ Great readiness of the player to take risks and decision-making process to find solutions in risky situations.
- ↪ A shorter preparatory phase when shooting may occur at any time (attacker is still dangerous)
- ↪ Very different tempo and rhythm changes are used during game.
- ↪ Effectively striking in a small group, especially in co-operation with the pivot in high level.
- ↪ The complete team concept and strategies reflect the individual qualities of each player.

### Teaching the basics of building up play and tactical structure

In general terms, being able to break through the opponent's defensive structure is a key to success. Attacking the goal, making space, penetrating in between defenders, beating defender (one-on-one), creating numerical advantage, attacking continuity and timing and accuracy of passes are decisive in building successful attacks against an organised defence. Therefore, developing tactical awareness about a balanced tactical organisation (width and depth), positional areas, and tactical roles is the foundation for effective build-up play learning.

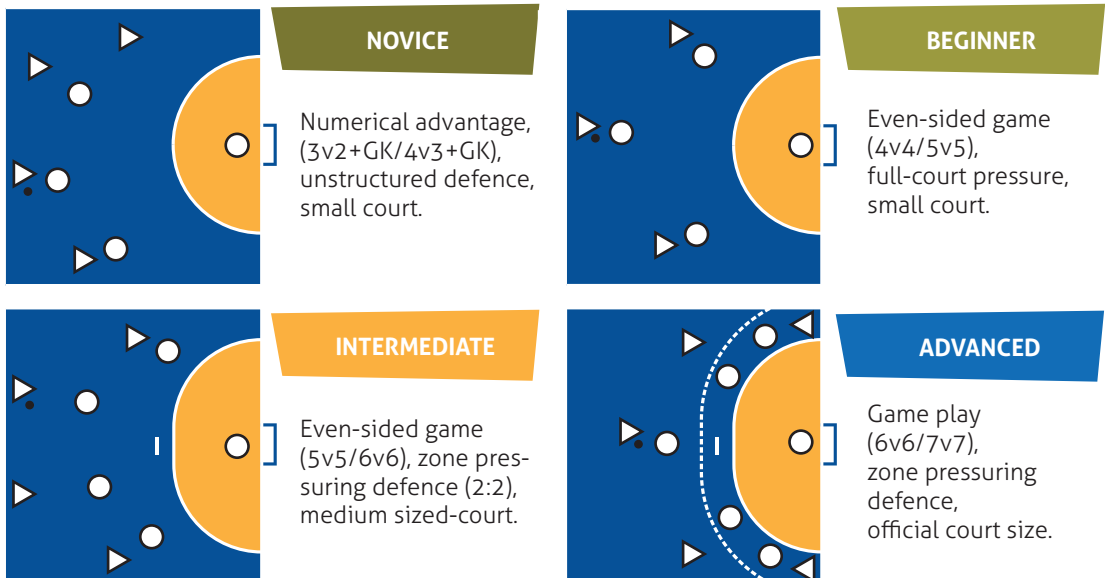

As different types of defence create distinctive game problems for attackers, and some can be quite demanding at a grassroots level, we advise being very careful when choosing them.

**Remarks:**

Therefore, we recommend using a kind of pedagogical progression, starting with how to build up play from the back against a full-court pressure defence, then, attacking against an open zone defence, and, finally, attacking against a more compact, two- and three-line and lined-up defence.

**Note: From a pedagogical perspective, the basic offensive principles and action rules to learn first are:**

- ↪ *Balanced attack (width and depth), by an effective spacing on court to create space.*
- ↪ *Use of teamwork to get free (give-and-go) to attack goal and to maintain ball possession (finding operative passing lanes).*
- ↪ *Without the ball, moving in an operative way to stay interconnected, creating playing options for themselves and their teammates.*
- ↪ *With the ball, always play attempting to effectively threaten the goal (initiating a pressure-play action or providing attacking continuity).*

## 7.2 Defence

The defensive phase formally begins when a team loses possession of the ball, but distinction has to be made between transition from attack to defence and positional defence.

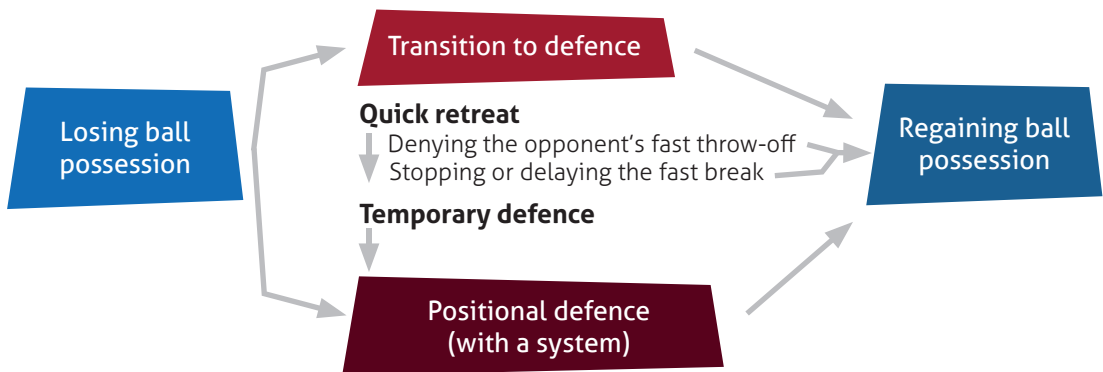

*Phases of defence*

## TRANSITION TO DEFENCE

Transition defence refers to the process of changing from offence to defence (also termed retreat). Transition defence can be as simple as exerting immediate pressure on the ball by the closest defender, with the rest of the team hustling back quickly to prevent passing to an open receiver and to protect the goal. Or, if the opponent is a fast-breaking team, it may require employing a full-court pressure defence while quickly retreating, attempting to steal the ball and to slow down the fast break. Once the opponents' fast break has been stopped, a temporary defence may be formed until it is possible to organise the intended system, making the necessary adjustments as fast as possible.

### New trends in transition phase – retreat:

- ↪ Fast transition to defence (in attack thinking about quick retreat).
- ↪ Full-court pressure against the opponent's fast break.
- ↪ Readiness to risk (not be afraid of risky solution).
- ↪ Tactical rhythm changes.
- ↪ Variable defence against fast break.
- ↪ Game in tempo with limitation of substitution of specialists (defender).

## POSITIONAL DEFENCE

Positional defence begins when the defensive players are properly arranged into their intended system. Different tactical organisations may be employed with a deep (3:2:1 or 3:3) or shallow configuration (6:0). But in modern handball, the systems tend to use a very pressuring, anticipatory and flexible behaviour independent of the initial tactical configuration. So, even when not having possession of the ball, the defenders are playing in an offensive mode to get the ball back. The aim of this new approach is to provoke offensive mistakes, to break the flow of the game and to get the ball back as quickly as possible. So, the basic idea is to keep the defensive compactness and pressure especially at the centre of the system, which requires great individual skills in one-on-one situations, shared responsibilities and excellent teamwork.

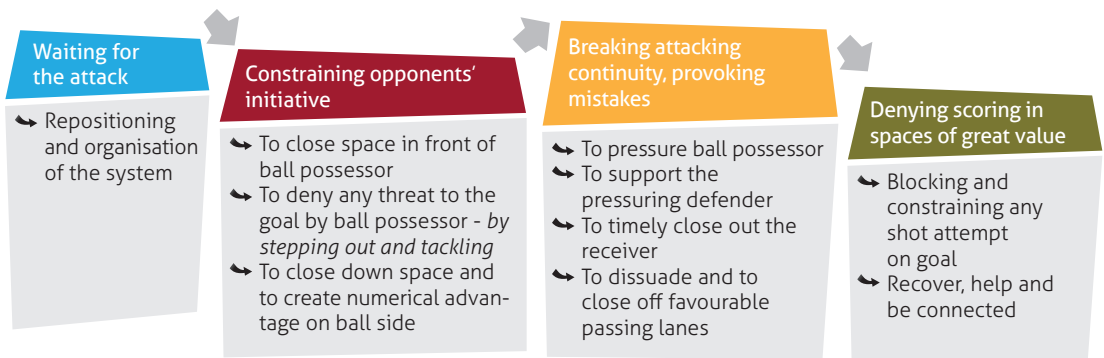

*Moments and principles in a positional defence acting with defensive pressure*

## Defensive organisation and forms of acting

In a broad sense, the defensive formation describes how the players on a team are positioned on the field. Many variations are possible, depending on principles, action rules and strategy being employed. So, the configuration of play might be more individualised (man-to-man defence), supportive (zone defence) or a combination of both (combined defence):



*Different forms of defensive configuration*

### New trends in defence:

- ↪ Ball-oriented defence (priority regaining the ball).
- ↪ Very active defensive game based on a lot of provocation against attacker (closing space).
- ↪ Basic defence systems and its various alternatives (mix of systems and fluent switching in between).
- ↪ Great flexibility with individual freedom of players (players play at the limit of risk).
- ↪ Limited substitution of attack/defence specialists (players are more complete in all game phases).

## LEARNING TO DEFEND AT SCHOOL

When teaching beginners to defend, we should first be aware of its pedagogical role, as different types of defensive organisation and forms of acting will constrain or compel certain playing solutions. So, we recommend selecting the ones that are more suitable for learners' level of knowledge, development and skills. Also, we should take into consideration what kind of methodological approaches are more appropriate to develop skillful players that, in the future, can easily interpret new defensive trends.



## 8. HANDBALL SKILLS AND TECHNIQUES

Basic movement skills are the foundation of any sport-specific technical repertoire. Learning these skills is the first step toward gaining a greater understanding of the technical skills required to play handball. Good lesson planning decisions begin with this understanding of the relationship between basic movement skills and technical skill acquisition.

It is well known that the modern handball player has to be a very skillful and complex athlete. He/she is a jumper, thrower, sprinter, strength athlete with very high coordination and balance all in one, and must execute these skills at high speed and with precision.

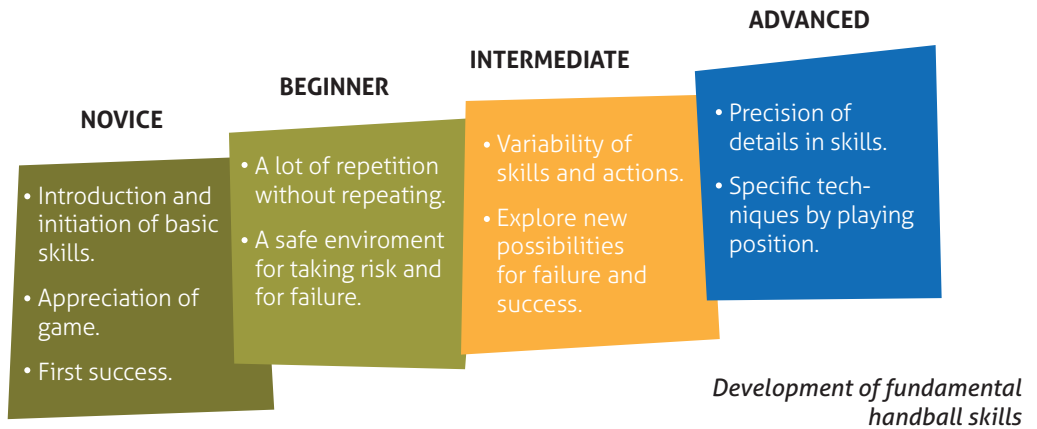

Individual technical handball skills which are necessary to perform in a game can be divided into three categories:



Encompassment of all skills leads to more effective play and to enjoyment from the game. Take care to improve variability and to practice individual skills through BGF, PGF and small-sided games focused on handball.

**Remarks:**

It is important to note that in the game there are between 10 (mini handball) and 14 (handball) players at the same time on the court with only one ball. This means most of the time players are without the ball. Therefore, activities focused on developing skills without the ball are very important.

## 8.1 Basic Attacking Skills

We can devise basic individual attacking skills by several tactical roles according to situational constraints. We describe the basic link between player with the ball who leads the game and the teammate who supports the attacker with the ball.

### Attacker with the ball



### Attacker without the ball



Reading the situation to be able to predict/imagine actions, to adapt choices from large variability of solutions with correct techniques, to react in good timing and to apply with success.

### BALL HANDLING

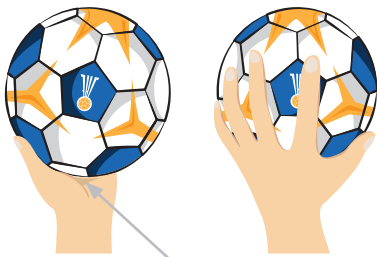

*Gap between the palm and the ball*

The player should **hold a ball with the fingers**. The thumb is almost opposite the little finger, and the last phalanges grip a ball strongly so that the player in motion, or in various activities, does not lose control of the ball.

Players can play the game and learn a correct throwing technique with balls whose sizes correspond to the size of their hands. The most common mistake is to carry the ball in the palm of the hand. Therefore, check to make sure there is a small gap between the palm and the ball.

While playing, players should not focus on the ball itself, but should perceive other factors as well (e.g., own position, positions of teammates, positions of opponents, position of goalkeeper).





### **Good techniques of ball handling permit player to:**

- ↪ Take information about other factors and action without having to concentrate on the ball.
- ↪ Move up the court quickly.
- ↪ Fake with greater certainty of success.
- ↪ Shooting and passing with greater precision and rotation of the ball.

### **BALL MANIPULATION**

The aim of ball manipulation is to teach the student the feeling of the ball. The object of the game is that the ball has to become part of the player. The player should be as fast, agile and skillful with the ball as without the ball. Ball manipulation improves confidence and creativity when handling the ball.

### **Good techniques of ball manipulation permit player to:**

- ↪ Take information about other factors and actions without concentrating on the ball.
- ↪ Better reception of the ball.
- ↪ Better control during ball handling and dribbling.
- ↪ Fake with greater certainty of success.
- ↪ Shoot and pass with greater precision, especially after difficult reception.

### **CATCHING**

Catching the ball is a principal technical skill in handball. Accurate catching is very important and ensures a fast, smooth and efficient game. Catching the ball with two hands is the best technique for beginners. Fingers should be relaxed and properly placed on the ball, providing shock absorption during impact. Additional elements, which are important while catching, are the speed of movement, proper positioning in regard to the path of a ball and immediate preparation for the following activity.

Receiving the ball includes whole body positioning, most importantly the relation to teammates and opponents on the court. The attacker must try to receive the ball in a way which will allow them to take the ball into space and away from pressure.

The most basic two-handed catching is done at chest level (face-to-face and sideways). But there is a huge diversity, depending on the situational constraints, such as at upper and lower levels, in mid-air, after bouncing, from the ground (with the help of the other hand), etc. One-handed catching is an advanced skill for the majority of learners.



A player rotates the upper part of the body, stretches their arms in the direction of the flying ball. Fingers are spread, index fingers and thumbs point to the other hand and create the shape of an **inverse heart**. In the moment of contact of ball and fingers, the arms bend at elbows, withdrawing to the direction of the chest (this lessens the impact of the pass), and after taking control, they immediately move into throwing position.

When catching the ball below the waist, a player performs an underarm catch of the ball. Arms are stretched in the direction of the flying ball, fingers spread, **little fingers** pointing to each other. After contact, the arms bend at the elbows and move near to the chest, directing the ball forwards, preparing for the pass.



### Good techniques of catching permit player to:

- ↪ Make next action (faking, passing, dribbling, shooting, etc.) quickly.
- ↪ Be immediately dangerous to opponent.

## PASSING

The player with the ball is responsible for passing the ball to a teammate. The player needs to take into consideration the direction, distance, timing and choice of the right kind of a pass. A pass must be accurate (not too strong and not too weak), fast (make decision of the situation quickly) and tactically useful (teammate in a good position, ready to receive the ball).

### Basic techniques of passing:

- ↪ Passing with dominant/non-dominant hand.
- ↪ Put arm with the ball behind and over the head and above shoulder level.
- ↪ Step with leg opposite of throwing arm.
- ↪ Feet pointed to goal.
- ↪ Rotate upper part of the body to the direction of pass.
- ↪ Movement of the arm with the ball forward starting with the shoulder and finishing the movement with wrist and fingers giving the ball extra speed and direction.
- ↪ Player should coordinate and balance because player can obtain extra power in the pass by rotating the body and following through.

### Basic tactics of passing:

- ↪ Take in the information of which teammate is in the better position (what is the position of the defenders).
- ↪ Take in the information if the teammate is ready to receive the ball.
- ↪ Passing should be as simple as possible (without additional moves).
- ↪ Ball should be passed in front of teammate, considering the player's speed.
- ↪ Passing player is responsible for quality of the pass.
- ↪ A good pass is a pass a teammate can catch.

## Basic position of passing



Passes can be divided according to many aspects:

### Usage of arms:

- Two-hand pass (sticking from the chest, from behind the head)
- Dominant-handed pass
- Non-dominant-handed pass

### Distance of flying:

- Short pass
- Medium pass
- Long pass

### Path of flight:

- Straight pass
- Bounce pass
- Lob pass (curl pass)

### Activity of the thrower:

- Pass from a stationary position
- Running pass (in motion)
- Jump pass (preliminary stride, vertical)

### Employed technique:

- Overarm pass
- Wrist pass
- Back hand pass (behind the back/head)

**Good techniques of passing permit:**

- ↪ Teammate to catch the ball easier and in good timing.
- ↪ Teammate to get into an advantageous position.

**Note:** Players need to understand that passing is quicker than movement of the attacker with the ball. For short distances and quick passes, wrist or forearm passes are a fast and accurate way to pass the ball to a teammate.

## DRIBBLING/BOUNCING

In handball, medium-high dribbling is used more often by attackers than low or high dribbling. In this manner, the ball is led **alongside the body** so that a player does not kick it and can also protect it from an opponent. The ball is pushed down (NOT hit!) by moving the arm, forearm and wrist toward the ground.



### A player can dribble:

- ↪ In place, when walking or while running.
- ↪ With a dominant hand (right hand for a right-handed person).
- ↪ With a non-dominant hand (left hand for a right-handed person).
- ↪ By alternating between right and left hands.

**Note:** Dribbling is one of the last skills we introduce to children, first as a single bounce between steps and then as other techniques (low, middle-high, in place, while moving, switching from standing position to sitting position, etc.). Without dribbling, students must rely on their teammates, play together, take information and concentrate on opponent and teammate activities. With dribbling, students look mainly to the ball and become disconnected from what is happening on the court around them. The main use of dribbling is for faking, moving up the court and during fast breaks.

### Good techniques of dribbling/bouncing permit player to:

- ↪ Keep the position of the ball longer than 3 seconds.
- ↪ Move up the court.
- ↪ Avoid an opponent.

## SHOOTING

The aim of shooting is to transport the ball into the rival's goal according to the rules of handball. Shooting is the ending of attacking activity of a team. There are many similarities between shooting and passing, but during shooting the muscles of the hand, arms, legs, pelvic region and torso are extremely engaged, and the movement must be highly coordinated. The success of shooting is influenced by a series of factors:

- ↳ Power (velocity), rotation, placement of shot.
- ↳ Kinetics of the whole body of the shooter (when standing, walking, running, while falling, while jumping).
- ↳ Distance and the angle with respect to the goal.
- ↳ The suitability of a playing situation.

*There are many ways to shoot the ball:*



- ↳ Overarm one-hand shooting from the ground (used after starting or from a place).
- ↳ Underarm one-hand shooting from the ground, so-called sidearm shot (used primarily in the back-court positions).

- ↳ Overarm one-hand shooting while jumping used for an attack through the rival's defence, for finishing a fast break, etc.
- ↳ Shooting while falling into the opponents' goal area, for example, from the pivot's or wings' position.

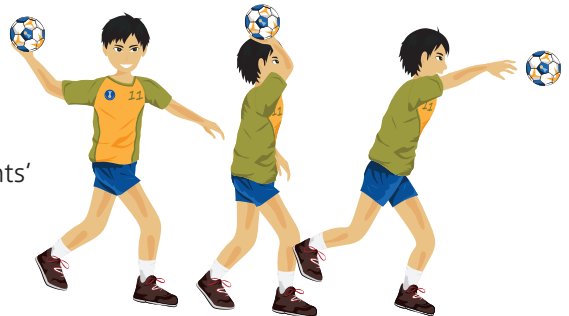

- 
- Shooting while jumping into the goal area for a fast break, jumping through the positions of backs, etc.
  - Shooting while jumping and rotating in the air (specific type of shooting when a player falls to the floor after the shot, lessening the fall with the non-shooting hand).

### Shooting can be divided according to:

- Path of the ball (straight, lob, bouncing off the ground, with rotation, etc.).
- Placement within a goal (the goal is divided into six/nine parts according to the view of the shooter).

**Note:** *High-quality shooting is the result of several activities that precede it (moving without the ball, receiving the ball, coordination of the body, dissociation of movements, rhythm and timing of motion, situation evaluation, choice of shooting and placement of shot).*

## FAKING

A fake consists of one or several movements which are similar to running, catching, dribbling, passing, shooting, followed by the performance of the real action. A player's talent is not limited to the ability to execute the game plan in accordance with the given set of rules, but also to the skills to outwit the opponent. A player who begins learning fakes should already have a certain flexibility, coordination, dissociation of movements, the ability to hold a ball in one hand, ball manipulation, etc.

The purpose of faking is to disengage from the defender and to be able to receive the ball safely from a teammate or to be able to get into a better shooting or passing position, and to create necessary space for a teammate.

To be successful, players must have creativity and make good decisions during the performance of fakes, provoking the defender to move and then responding accordingly to it. The aim of faking is to gain an advantage through a certain player action and an adequate reaction to it. Based on actions performed by players, fakes are generally divided into:

### Ball Fake

- Pass fake
- Shot fake

### Body Fake

- Without the ball
- With the ball

## Body fake without the ball

The basic principle of faking without the ball is moving to an open space and then acting on the reaction of the defender to the initial movement.

### Attacker:

- Moving to the open/free space with respect to good spacing (approximately 2 metres).
- For disengaging from the defender use variability of speed, changes in direction of movement, etc.

### Defender:

- High activity with the legs and with the arms up.
- Close free space, protect goal and if the defender has opportunity try to intercept the ball.
- Protect the centre of the court and force the attacker to a side.

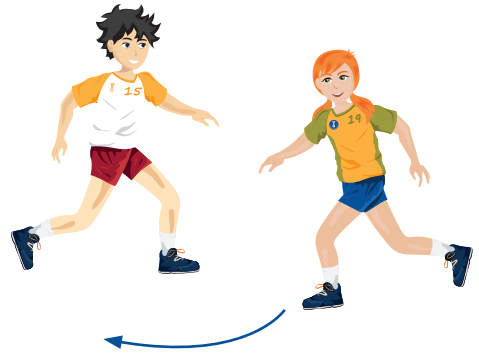

## Body fake with the ball

Activities for faking with the ball can be divided into three basic steps:

### Step 1

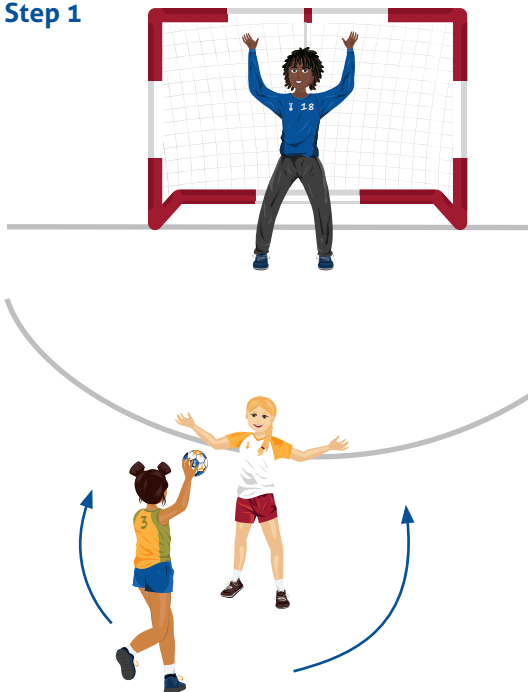

### Attacker:

- Good spacing (not too close/far from defender - approximately two arms lengths away).
- Attacking the free space (inward or outward).
- Holding the ball far from the defender (protection), and being ready to shoot at every moment during the movement.
- If the defender does not close space, the attacker has to accelerate straight to the goal and shoot.

### Defender:

- Put pressure on attacker (getting close, active legs, waving with arms, etc.) and close free space.
- Protect the centre of the court and force the attacker to a side.

## Step 2



### Attacker:

- ↪ Can use pass fake, and if defender reacts, attacker has to accelerate straight into the free space and shoot.
- ↪ After direct movement and closing this space by defender, attacker needs to change direction (side-step, use single bounce or dribbling, cross-step, etc.) to gain the space.
- ↪ If attacker makes step to left, only to move defender in this direction, then follows long step to the right to gain space (shifting the body balance).

### Defender:

- ↪ React to attacker movement such as acceleration, change of direction and/or dribbling to close space and protect goal.

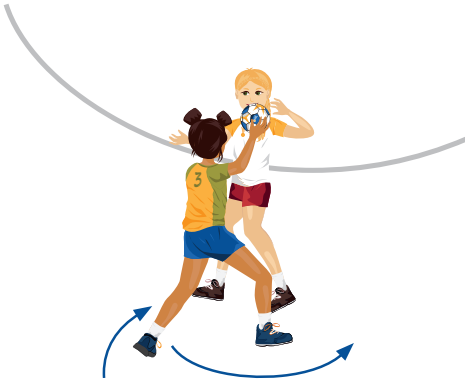

## Step 3



### Attacker:

- ↪ If attacker regains space, the last step has to be towards the goal to create a chance for shooting.
- ↪ Needs to rebalance and coordinate before shooting.
- ↪ Can make a shot fake and throw the ball to a teammate (if the space gained is not good for shooting, creating space for teammate).

### Defender:

- ↪ Continue high activity with the legs and with waving arms to close space and protect goal (e.g., make pressure, provoke smaller angle for shot or wrong pass, etc.).



**Note:** Begin teaching faking movements on a large space and gradually reduce the space as proficiency improves. The player should explore the open spaces between defenders (e.g., use changes of speed, unexpected starting and changes in the direction of movement, etc.) for his/her releasing. Successful faking depends on the ability to decide, accurate timing, and the right interpretation of the playing situation.



## 8.2 Basic Defence Skills

The inseparable part of handball is the defensive phase of a game. This is a very difficult task for a PE teacher, because pupils like to attack and to score goals. However, an experienced PE teacher can manage to highlight the importance and the basis of defence.

In modern handball, players possess a high level of motoric skills, tactical thinking, fast reaction, anticipation of situations, counteraction to the opponent's intention, etc. Individual defensive skills include posture, side-to-side stepping, jumping, running, running backwards, stopping and changing direction, reaction to fakes, interception of the ball, blocking the ball, etc.

### Defender of attacker without the ball



### Defender of attacker with the ball

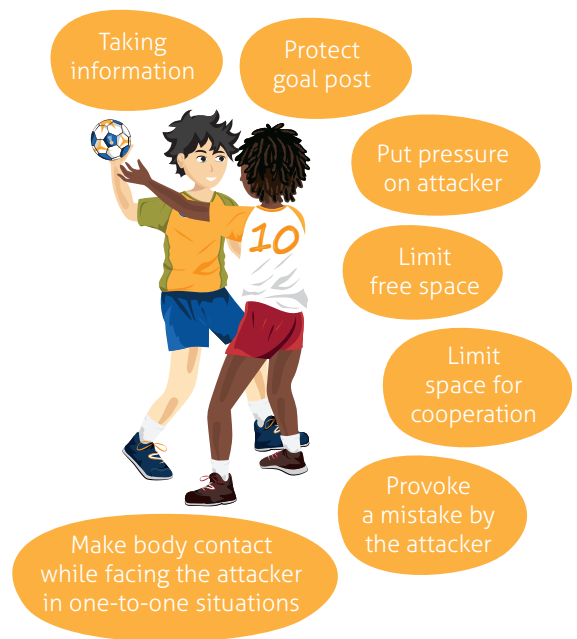

### Defending position

The defending position, or guard, is used to hamper a quick start and prevent further coordinated movement. A stable posture is required during personal clashes during the defensive part of a game. From this basic defensive position, the movement is performed by a series of quick steps, transferring the weight to the front. PE teachers should make sure a player does not jump with both legs or cross legs while moving sideways.

Immediately after losing the ball, a player should position himself/herself between the attacker and the goal.

## ***Defending position and control of the attacker without the ball***

From a position with feet shoulder-width apart, a player should use short, fast steps to defend, never crossing over as he/she moves, waving the arms while looking up at the attacker and not down at the feet. The basic defensive position seeks to control and to prevent an attacking player from shooting at the goal or making a break-through. In handball, we sometimes speak of 'defending with your feet', requiring players to be fast on their feet, maintaining good positioning regarding an opponent.

In many defensive actions, the player is using arms to disrupt the attack, to intercept the ball, to block the shot, or to break up the pass. By waving the arms in this defensive position, the player can also reduce the field of vision of the attacker.

We place great emphasis on the work of the legs, the correct positioning between the attacker and the goal, the adequate distance between the defender and the attacker, and the work of the arms. We avoid contact for beginners, because they first need to learn good positioning and the correct timing of action.

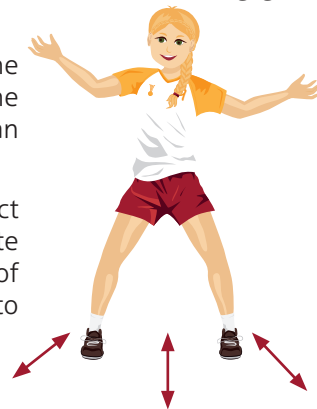

## ***Defending position and body contact in close one-to-one situations against attacker with the ball***



The primary responsibilities of the defender in this situation is to stop the attacking player from shooting at goal, making a break-through, or setting up a shooting opportunity for a teammate. It is important for the defender to never stop working with the legs before and during contact with an attacker, using small steps as previously discussed.

To control the movement and spacing of the attacker, the leg of the defender opposite of the attacker's throwing arm should be in front. The defender should meet the attacker with bent arms. One arm should always go towards the attacker's throwing arm, and the other should be placed on the hip of the attacker. The defender should move his/her feet in the direction that the opponent moves during the tackle. When the defender has contact with the attacker, it is important to take control of the ball immediately (not only the arm).

**Note:** *The defender must provoke the movement of the attacker and anticipate his/her reaction in order to win the ball or force a technical fault and turnover by the opposing team.*

*In defensive systems, the defensive position and guard change slightly depending on the player's position in the system.*

## INTERCEPTING THE BALL

Building defensive awareness is a fantastic skill to develop in your students, as intercepting the ball can greatly help your team. Defensive awareness is a skill that focuses on looking at what the offensive team is doing, anticipating their next move through movement and body language, and seizing the moment to create a technical fault or turnover.

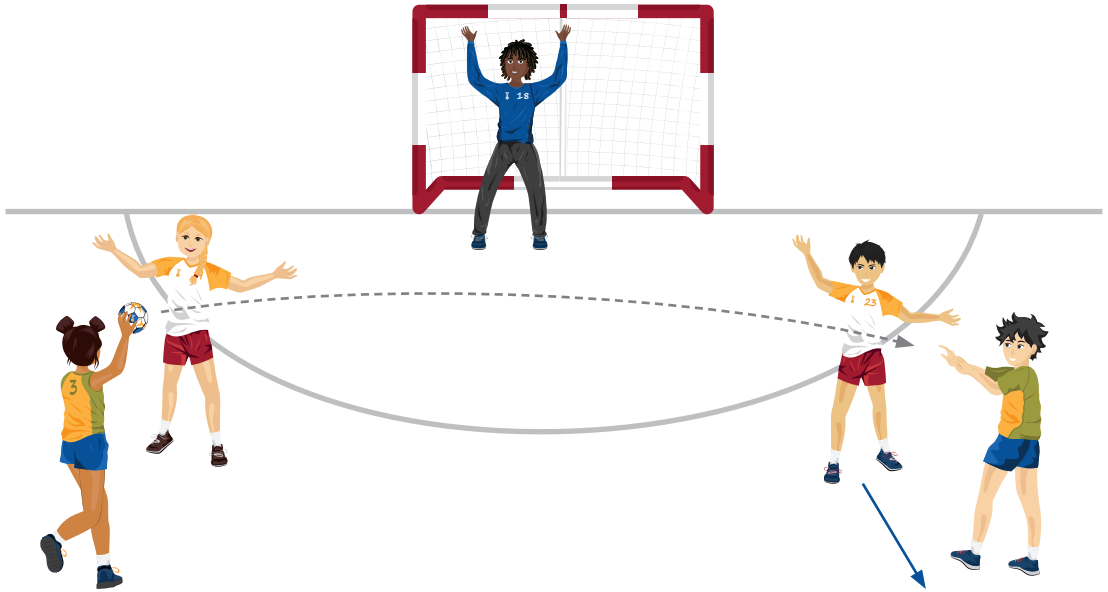

The defender tries to intercept the ball near the player who is receiving a ball.

## BLOCKING

Blocking with the arms or body is allowed to stop an attacker's pass or shot on goal, and to support the goalkeeper by defending a part of the goal. However, doing so with the legs (under the knee) is strictly forbidden. For some children, it is scary to place themselves in front of the shooting attacker and block with the arms.

The defender needs to be focused on the player with the ball and anticipate the trajectory of the shot. Because the technique for blocking shots requires jumping and being well balanced after contact with the ball or attacker, the defender must be careful during landing to ensure the safety of the attacker.

## Blocking



*Jump shot blocking*



*Run shot blocking*



*Underarm shot blocking*

**Note:** Blocking the ball is the last chance for a defender to stop a shot in progress (or to prevent a shot).

## 8.3 Basic Goalkeeping

Playing as a goalkeeper requires a lot of physical and mental effort. The goalkeeper is the only player that can move inside the goal area without restrictions. From the ages of 5 to 10, children should take turns in this role, as specialisation at this age is not recommended.

Students must tell you if they are brave enough to try this role. Do not force a pupil to play goalkeeper if fearful of the task. At the age of 10 or 11, players can start to specialise in at the position when playing in a club context of practice.

### An overview of specific goalkeeper's skills:

#### 1. Offensive skills:

- ↪ Movement in the goal area.
- ↪ Offensive posture, positioning.
- ↪ Passing to initiate fast break, attack, throws.
- ↪ Execution of free throw, goalkeeper throw, throw-in.

A goalkeeper is the only player who can shoot a goal from his goal area, but this case is rare even at professional levels of handball. The goalkeeper can come forward with the attack, but outside of the goal area he/she is almost under the same restrictions as court players.

## 2. Defensive skills

- ↪ Defensive posture, positioning.
- ↪ Using hands, legs and torso for saves.
- ↪ Catching, deflecting and knocking down shots.

The basic posture and position of a goalkeeper within the defensive phase of a game are the most important skills of the goalkeeper. The position can change according to the physical characteristics of a pupil (short, tall, robust, etc.). During the defensive phase of the game, it is important for goalkeepers to remember the following rules:

- ↪ Maintain good defensive posture with upraised hands.
- ↪ Stand in front of the goal line.
- ↪ Position between the goal and the shooting attacker.
- ↪ Time the action correctly (young players often perform actions before the ball arrives).



*Basic position of goalkeeper (low save)*

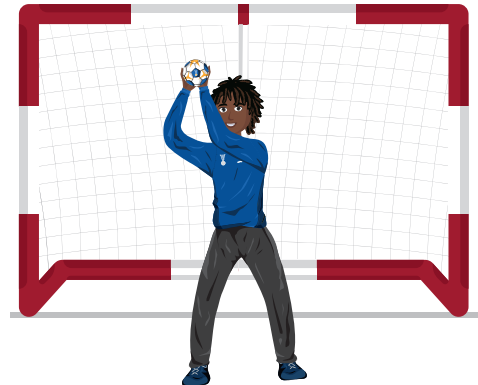

*High save of goalkeeper with both hands*

**Note:** The goalkeeper is the last defender to prevent a goal and usually the first attacker of the team. He/she must be ready to make the first pass (e.g., goalkeeper throw, throw-in, free throw, etc.) before celebrating a good save. In the defensive phase of the game, the goalkeeper plays an important role in team communication, because he/she can fully see the situation before him/her.

## 9. CHARACTERISATION OF STAGES IN THE TEACHING PROCESS

In this chapter, we will explain the basic characteristics of children's developmental stages, how you can determine the level of your students, pedagogical content and effective tasks for improvement. Thereafter, you will continue systematically in their development step-by-step. Basic characterisation linked to methodology are schematised in the table below:

### Key stages:

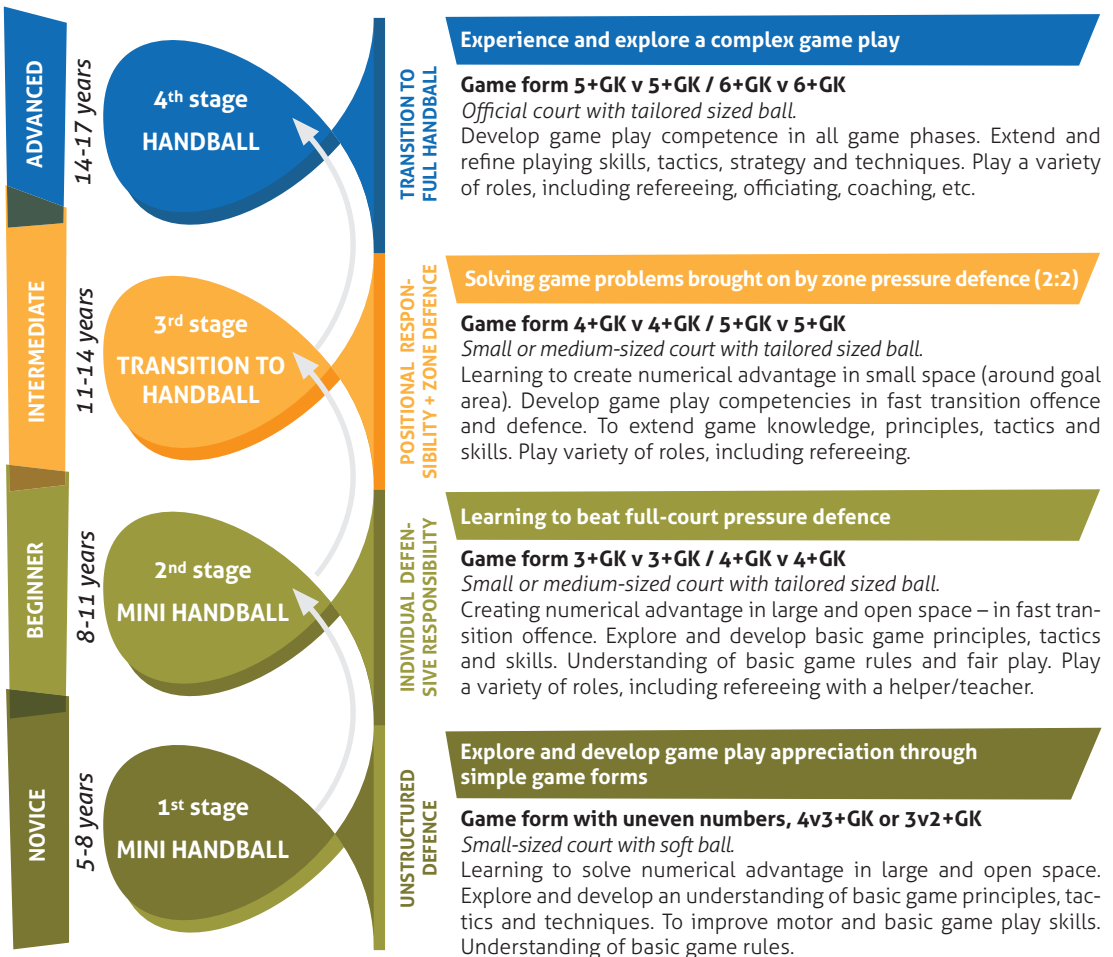

**Note:** The primary factor is the level and the secondary factor is the age of the children.



## Major offensive game problems and basic tactical elements to work on in each key stage of learning:

	NOVICE	BEGINNER	INTERMEDIATE	ADVANCED
Collective focus	Transitional play with numerical advantage	Transitional play with pressure	Introduction to differentiation of game phases: transitional and positional play	Development of game phases
Maintaining ball possession	Inter-passing skills functional spacing	Inter-passing under pressure Evading opponent to get open	Inter-passing in tight spaces and around goal	Inter-passing in numerical disadvantage
Making forward progression	Supporting play Spread-out positioning Lead pass Progression dribbling	Evading opponent to get open ahead of ball, lead pass Give-and-go in depth Replacement cut	Joint efforts to fast forward play Leading away to make space	Staggered passing lanes (waves)
Attacking the goal/scoring	Creating an opening Taking an open shot Shooting skills Solving advantage in wide-open space	Fake and cutting moves to create an opening Taking an open jump shot Creating advantage in wide-open space	Creating advantage in small spaces Pressure play from exterior Inward/outward penetration Switching play Ball fakes Shooting from narrow angles	Creating advantage in small spaces Pressure play with pivot Positional shooting Fake movements inside defence – pivot positioning and role Screening

## In defence, our tactical focus is on regaining the ball and protecting the goal, as detailed below:

	NOVICE	BEGINNER	INTERMEDIATE	ADVANCED
Collective focus	Unstructured defence	Full/half-court pressure	Quick retreat with pressure Rudimentary pressuring two-lined zone defence	Development of game phases Pressuring zone defence
Regaining ball and protecting the goal	Court players' and goalkeepers role Basic goalkeeper skills	Individual responsibility Close pressure to intercept the ball	Positional responsibility with mutual help to deny space and pressuring pass lanes	Individual positional responsibility to deny numerical disadvantage on ball side

## 9.1 Beginner Level – Mini Handball

### NOVICE – MINI HANDBALL

1<sup>st</sup> stage: Game form with uneven numbers (4v3+GK or 3v2+GK)

#### 1<sup>st</sup> STAGE: MINI HANDBALL - UNSTRUCTURED DEFENCE

##### **Main focus: attacking play**

With novices they tend to gather around the ball – **anarchic game.**



Encourage learners to adopt a spread-out position and spacing, which increases possibilities to retain possession and to make forward progression to attack the goal.

#### Use a game play with numerical advantage (4v3+GK/3v2+GK)

*Adapted rules:*

- After loss of ball, any player can rapidly assume the goalkeeper position (typically the closest to the goal). This self-applied routine promotes the concept that all learners can be the goalkeeper. For novices, we can decide which player will play the position.
- In cases when more than one defender runs inside the goal area and the opposing team performs a scoring attempt, a penalty throw is applied if unsuccessful. If scoring, the number of given points depends on the number of goalkeepers (e.g., two goalkeepers=two points).
- Use the protected ball rule, meaning that physical contact with attacker with the ball is avoided.
- Consider not introducing or emphasising the three-step rule. Instead, stress the need to look and find an open attacker to receive the ball. At this level, they tend to take three steps before performing any other action, which leads to a slower game play and high pressure on the attacker with the ball, making it more difficult for the attacker to make decisions and to throw the ball successfully.
- Limit the use of dribbling (e.g., allowing one bounce) or forbid its use to compel cooperation.
- After a goal, the goalkeeper should be instructed to put the ball straight back into play, instead of performing a regular throw-off from the middle of the court. This rule promotes fast transition play and a more dynamic game, while saving time and promoting enjoyability. If needed, do not allow intercepting the first pass from the goalkeeper.

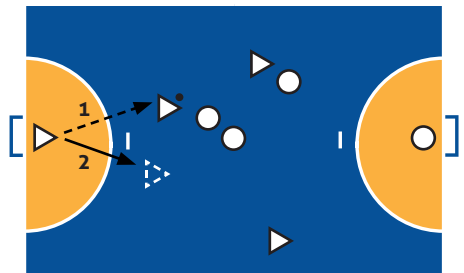



With novice learners, the usage of offensive numerical advantage and an empty goal will naturally lead learners to understand the importance of discovering open attackers to receive the ball (as there is always at least one) and to make more accurate passes. On the other hand, when they lose the ball, they will be aware of the immediate need to protect the goal (particularly when it is empty), otherwise the attacking team can get an easy shot.

At this level, we recommend not introducing individual marking, as it would make the game even more crowded. A lined-up defence around the goal area should also be avoided, as it will lead to a more static game with few scoring attempts. Instead, for example, instruct defenders to regain the ball by pressuring higher up, but only if needed.

### BEGINNER – MINI HANDBALL

2<sup>nd</sup> stage: Even-sided game (4v4 or 5v5) with man-to-man defence

## 2<sup>nd</sup> STAGE: MINI HANDBALL - INDIVIDUAL DEFENSIVE RESPONSIBILITY

With the change from an unstructured defence to a full court pressuring defence, learners will be confronted with more demanding game problems (time-space to make decision and to execute action decreases).

This type of defence is a rudimentary form of defensive organisation to exert pressure and to regain ball possession. By defending higher up the court, the players will be active and make more interceptions, which will trigger fast breaking play. At the same time, they will develop defensive skills (including footwork and tackling).

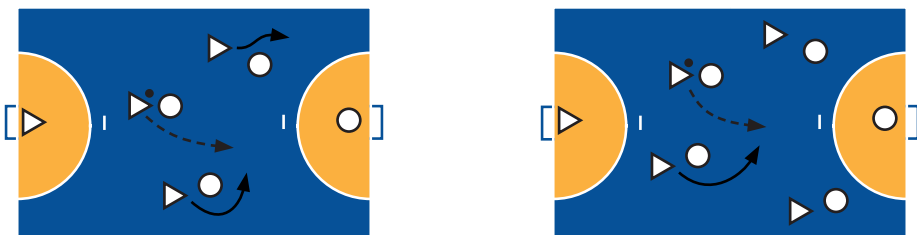

*Even-sided game (4v4 or 5v5) with full-court pressure and, then, half-court pressure*

### Recommendations:

Set up teams with balanced pairings (individual marking), like the best defender is responsible for the best attacker.

In the beginning, it might be useful to constrain defensive pressure, for some youngsters, by discouraging or not allowing physical contact with attackers (one-arm-away rule).

This variation will also lead the defender of the attacker without the ball to learn to apply close marking while paying attention to the ball. In any case, do not tolerate situations in which the physical integrity of players is put in danger.

Players use dribbling without restriction.

At this stage, the defensive form of acting is instrumental in learning the attack process, because it will compel the need for moving without the ball, dealing with the direct opponent's pressure in their own benefit (evades opponent to get free ahead of the ball) or teammates' benefit (moves away to create space or get open to support attacker with the ball). Becoming conscious of game problems provoked by full court pressure and ways of solving them, should be the first approach in game play context and, then, in more simplified situations as the kind proposed below.

## 1<sup>st</sup> AND 2<sup>nd</sup> STAGE IMPLEMENTATIONS

### Maintain ball possession

1<sup>st</sup> stage

Passing and moving the ball away from opponents is one of the most basic principles to learn from the very beginning. Therefore, receiving-passing skills while running should be intensely worked at this level. It is also essential to achieve basic understanding of support and space. Getting into an open passing-lane to receive the ball is a critical task to learn.



2<sup>nd</sup> stage

When introducing individual defensive responsibility, the instructional process should focus on developing space awareness and learning how to outwit the opponent in close marking situations in order to get open and receive the ball. Also, the attacker with the ball needs to deal with pressure, protecting the ball (forming the arm-throwing position) and employing pass fakes to get defenders unbalanced and out of position, creating an open path to pass the ball.

	Tactical concepts/ skills	On-the-ball skills	Off-the-ball actions	Designing learning tasks
1 <sup>st</sup> stage	<ul style="list-style-type: none"> <li>Inter-passing skills</li> <li>Functional spacing</li> <li>Overarm pass</li> <li>Bounce pass</li> </ul>	<ul style="list-style-type: none"> <li>Ball handling/ manipulation of ball</li> <li>Chooses and accurately passes ball to an <i>open</i> attacker</li> </ul>	<ul style="list-style-type: none"> <li>Moves toward free space and gets open to receive ball</li> <li>Steps to successfully catch ball</li> </ul>	<ul style="list-style-type: none"> <li>Lead-up games (throwing and chasing games)</li> <li>Inter-passing drills without defensive pressure and with constrained pressure</li> <li>Passing game 3v3 and with numerical advantage (3v2/2v1)</li> <li>Diverse ball handling and coordination drills</li> </ul>
2 <sup>nd</sup> stage	<ul style="list-style-type: none"> <li>Inter-passing skills under pressure</li> <li>Evading opponent by using body fakes without ball</li> <li>Give-and-go for a returning pass</li> <li>Fake passes</li> </ul>	<ul style="list-style-type: none"> <li>Improvement of ball handling/ manipulation of ball</li> <li>Chooses and accurately passes ball to an <i>open</i> attacker under pressure</li> </ul>	<ul style="list-style-type: none"> <li>Adjust position/ movements as needed in the flow of the game</li> </ul>	<ul style="list-style-type: none"> <li>Lead-up games (e.g. multiple goals game)</li> <li>Passing games 3v3, 2v2 (with and without supporters) and 1v1 (with supporters)</li> <li>Go-for-goal tasks (3v3, 2v2 and 1v1, with close marking)</li> <li>Game play 2v2, with supporters in half/ full-court</li> </ul>

## Making forward progression

**1<sup>st</sup> stage** At this stage, it is critical to become conscious of the open space and why its spacing occupation is important to create passing lanes (preferably at the side and ahead of attacker with the ball) in order to move the ball up court and to have the chance to get an easy scoring opportunity (1vGK). The dribble is one of the most important resources to progress toward the goal. However, learners should be instructed to use it only when isolated to attack goal. Systematic use of dribbling usually means lack of game sense (they are not reading the game before receiving), slows the game play and leads to excessive individualisation.

**2<sup>nd</sup> stage** When learning to make forward progression facing individual close marking, the main focus should be placed on spreading out the attack to make space by using the width and depth of the field. While defenders look to pressure and to provoke mistakes, attackers must concentrate on making joint efforts to retain ball possession while making forward progression and to create numerical advantage, by beating opponents without the ball.

	Tactical concepts/ skills	On-the-ball skills	Off-the-ball actions	Designing learning tasks
1 <sup>st</sup> stage	<ul style="list-style-type: none"> <li>Spread-out positioning</li> <li>Supporting play</li> <li>Lead pass</li> <li>Give-and-go</li> </ul>	<ul style="list-style-type: none"> <li>Recognises when to pass or to progress (dribbling if needed)</li> <li>Executes a lead pass to a free teammate ahead</li> </ul>	<ul style="list-style-type: none"> <li>Adjust position:               <ul style="list-style-type: none"> <li>• Moves away adopting an open position</li> <li>• Runs into open spaces, to receive, creating an opening</li> </ul> </li> <li>Having passed the ball, continues moving</li> </ul>	<ul style="list-style-type: none"> <li>Lead-up games (invasion/ territorial games)</li> <li>Group progression tasks, with and without defensive pressure</li> <li>Game play 4v3+GK, 3v2+GK, 2v1+GK, with open space</li> </ul>
2 <sup>nd</sup> stage	<ul style="list-style-type: none"> <li>Inter-passing skills under pressure</li> <li>Fakes without ball</li> <li>Cutting moves</li> <li>Give-and-go for a returning pass</li> <li>Lead pass</li> </ul>	<ul style="list-style-type: none"> <li>Squared up to goal, reads the play and seeks best decision:               <ul style="list-style-type: none"> <li>• With pressure, protects ball and looks for a free attacker</li> <li>• Uses fake passes, if a defender is in the passing lane</li> </ul> </li> <li>Having space and without an open attacker, plays one-on-one.</li> </ul>	<ul style="list-style-type: none"> <li>Adjust position:               <ul style="list-style-type: none"> <li>• Moves away adopting an open support position</li> <li>• Gets open preferably ahead of ball, by evading defender (1v1)</li> </ul> </li> </ul>	<ul style="list-style-type: none"> <li>Lead-up games (e.g., end-line handball, multiple goals game), go-for-goal tasks 3v3, 2v2 and 1v1, with close marking,</li> <li>Fast-breaking tasks 4v3+GK, 3v2+GK, 2v1+GK</li> <li>Game play 2v2, with supporters in half- and full-court</li> </ul>

## Attacking the goal and shooting

1<sup>st</sup> stage

Here, it is fundamental to develop players' initiative to threaten goal and to be able to understand when there is a good situation to score. It is very challenging to change a poor technique with youngsters, so it is important to learn how to throw correctly from the very beginning. Start by teaching the basic stationary overarm shot, focusing on the arm-throwing position and stepping forward onto the opposite foot to the throwing arm (e.g., right-handed thrower=left foot). At first, initiate this shot close to the goal, or a target, like a cone, then move back, adding one-, two- and then three-step approaches, and then finally from even further away, after receiving the ball and with dribble-approach, as shooting skills improve.

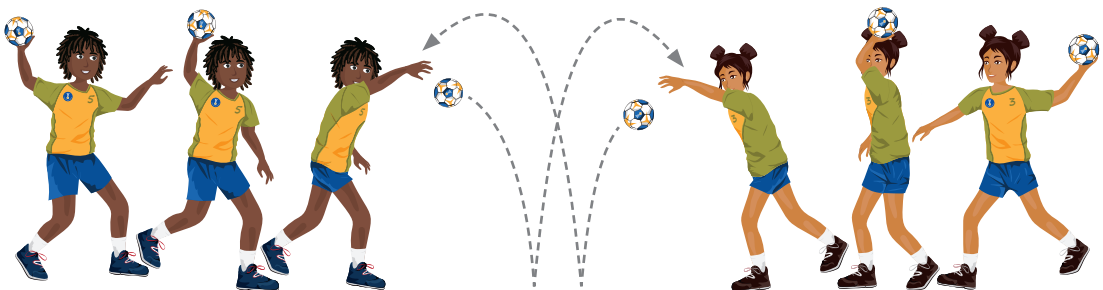

*Shooting on the ground/floor with maximum strength*

**2<sup>nd</sup> stage**

To develop shooting skills is one of the main teaching goals, and it should continue to be exercised, along with coordination. The ability to outwit opponents will allow attackers to open up avenues to the goal, and should be progressively developed, first, without the ball and, then, with the ball in large spaces.

	<b>Tactical concepts/ skills</b>	<i>On-the-ball skills</i>	<i>Off-the-ball actions</i>	<b>Designing learning tasks</b>
<b>1<sup>st</sup> stage</b>	<ul style="list-style-type: none"> <li>Creating an opening</li> <li>Taking an open shot</li> <li>Shooting skills</li> </ul>	<ul style="list-style-type: none"> <li>Squares up to goal</li> <li>Shoots in a balanced manner, with appropriate arm-throwing motion</li> <li>Linking the catch with one running step and forming the throwing position</li> </ul>	<ul style="list-style-type: none"> <li>Knows where to be positioned to give support, and execute run-up approach to receive and to attack goal</li> </ul>	<ul style="list-style-type: none"> <li>Lead-up games (throwing/ target games)</li> <li>Throwing with diverse coordinative and motor tasks, 1vGK in front of goal</li> <li>1v1, with defender out of position</li> </ul>
<b>2<sup>nd</sup> stage</b>	<ul style="list-style-type: none"> <li>Outwitting opponent</li> <li>Duels without ball (1v1)</li> <li>Give-and-go for a returning pass</li> </ul>	<ul style="list-style-type: none"> <li>Squares up to goal, jump shot. Employs straight penetration or misdirection-penetration.</li> <li>If next defender commits, assist teammate (2v1)</li> </ul>	<ul style="list-style-type: none"> <li>Body fakes/ cutting moves to beat opponent, getting open to receive and attack goal</li> <li>Is ready to receive, threatening goal and to exploit the open space</li> </ul>	<ul style="list-style-type: none"> <li>Lead-up games (e.g. throwing/ target games), 1v1 with ball, with defender out of position or constrained, 1v1, in large space and with supporter(s)</li> <li>Throwing with diverse coordinative and motor tasks</li> </ul>

### Regaining the ball and protecting the goal

**1<sup>st</sup> stage**

When first introducing novices to mini handball (game play with uneven numbers), it is counterproductive to focus the instructional process on defensive skills, however, some concepts must be introduced, such as protecting the goal and regaining possession. Here, it's important to understand what to do immediately after losing ball possession, differentiating the defenders and goalkeeper role. Defenders should be encouraged to be active and to try to get back the ball, while the goalkeeper should be aware of correct positioning to protect the face/head and to save the ball.

**2<sup>nd</sup> stage**

With the introduction of individual defensive responsibility, students should learn that they must choose the closest attacker to mark immediately after losing ball possession, rather than trying to find the pre-assigned opponent, which should only be prescribed when there are players with huge differences in competence to avoid unbalanced confrontation.

	<b>Tactical concepts/ skills</b>	<i>Defender of player with the ball</i>	<i>Defender of attacker without the ball</i>	<b>Designing learning tasks</b>
<b>1st stage</b>	<ul style="list-style-type: none"> <li>Role of court players and goalkeeper</li> <li>Basic goalkeeper skills</li> </ul>	<ul style="list-style-type: none"> <li>Positioning between the attacker with the ball and the goal</li> </ul>	<ul style="list-style-type: none"> <li>Look out for ball</li> <li>Interception/ to catch ball</li> </ul>	<ul style="list-style-type: none"> <li>No great preoccupation exists in setting up specific learning tasks to learn these concepts and skills. However, they should be approached in game play context and in every learning task where there are these functions.</li> </ul>
<b>2nd stage</b>	<ul style="list-style-type: none"> <li>Individual defensive responsibility</li> <li>Close marking concept</li> <li>Tackling skills (1v1)</li> </ul>	<ul style="list-style-type: none"> <li>Step up to close-out/tackle, denying progression and shooting</li> </ul>	<ul style="list-style-type: none"> <li>Exerts pressure to close off passing lane, dissuades or intercepts ball</li> <li>Tracks opponent without being beaten and knowing where the ball is</li> </ul>	<ul style="list-style-type: none"> <li>Depending on learners needs, it might be needed to focus more on defensive skills. Most often, these skills are learned during game play integrated with offensive tasks.</li> </ul>

## 9.2 Intermediate Level – Transition to Handball

3<sup>rd</sup> stage: Introduction to positional play, zone defence

The decision to move to a more demanding game play should rely on players' level of competence. At this stage, it is expectable that learners play more fluently on the entire court and know how and when to beat his/her opponent in large spaces to attack the goal.

Passage to a rudimentary form of zone defence confronts the learner with the need to take up and maintain a balanced attack, to learn to gain an advantage over his/her opponent (1v1 with ball) and to work together in more reduced or tight spaces.

Zone defence can take different forms of acting, according to teaching goals: match-up zone defence (on-ball defender steps out and plays tight), pressuring higher up on ball's side (including nearest receivers) and two-line zone defence (formation 2:2). However, by using a two-line defence (2:2) at this level, attackers will have more (stable) space between defenders to exploit, which can boost the use of diverse offensive solutions, with and without the ball, and joint actions. This development in defensive pressure can affect the understanding of positional responsibility, improvement of individual skills (duels) and teamwork.

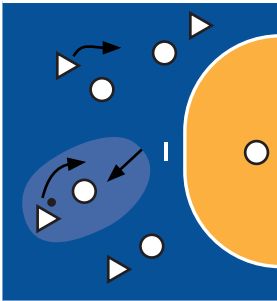

**Game form:**

5v5 game play, with a rudimentary form of zone defence, in a small- or medium-sized court.

A two-lined defence is recommended.

**Alternative game forms** – adjust the number of players to best suit the available court size:

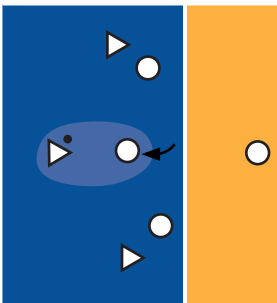

*Small-sized courts*

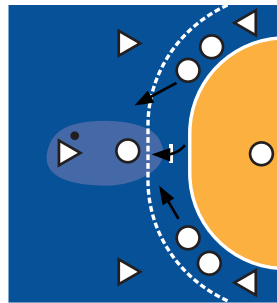

*Large-sized courts*

Regardless the need to continue to develop learner's skills to maintain ball possession and to make forward progression (enhancement of fast breaking skills), at this level the instructional process should focus on learning how to break through against a pressuring zone defence.

**Recommendations:**

Here, it is important to introduce self-rotation rules for students to experience different court playing positions (see the examples below).

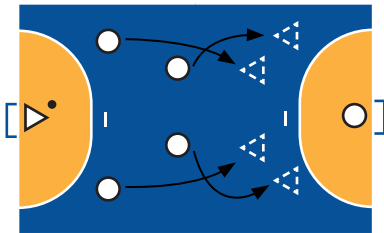

**Fast breaking structure with 2:2 defence:**

The forward-advanced defenders should transition up the court to the wing position, while the outside defenders should support the goalkeeper and transition up the court with ball progression to the back position. When returning to defence, the wings should transition to the outside defender position, and the backs should transition to the forward-advanced position, and so on.

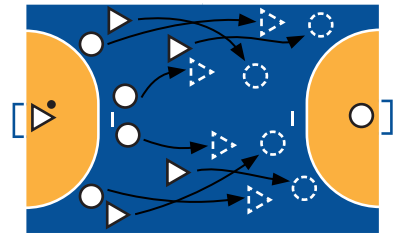

**Fast breaking structure with match-up zone defence (more lined up):**

The outside defenders run up to the wing and the inside defenders to the back positions. Here, the inside defenders are responsible for the forward ball progression. When retreating, the wings become inside defenders and the backs become outside defenders, and so on.

## Creating and exploiting numerical advantages against zone defence

Now the focus is on how to get an opening with outnumbered play against a more compact, but still pressuring, zone defence. The passage to a rudimentary form of zone defence confronts the learners with the need to take up and maintain a spacing position to stretch (or spread) out defenders. In this way, the possibilities for defensive coverage and help will be more limited and, consequently, the attacker will ensure more space to work with teammates to maintain possession of the ball and to break through the defence.

The concept of balanced attack, with wingers placed at the corners should now be focused on. It is essential to learn to adopt a wide-open positioning when a teammate is in possession of the ball, to support him/her and to give attacking continuity.

### Breaking through defence – creating numerical advantage

At this level, to get an opening into valuable spaces fundamentally depends on the players' successful one-on-one with the ball. Players need to be aware of making space before receiving the ball and to attack the space/goal instead of the defender. Learning how to beat an opponent by using ball fakes (such as misdirection penetration) is necessary in order to get open to score (1vGK) or to attract the next defender, thus freeing a teammate (2v1). When a teammate with the ball initiates a pressure play action, the nearest attacker needs to be aware of what to do to support him/her and, if possible, to get free to attack the goal in small space.

Tactical concepts/skills	On-the-ball skills	Off-the-ball skills
<ul style="list-style-type: none"><li>• Balanced attack.</li><li>• Inter-passing skills under positional pressure.</li><li>• Side pass toward the same and the opposite side of throwing arm (overarm and wrist pass).</li><li>• Fakes with ball: fake passes, fake shots and misdirection penetration.</li><li>• Repositioning movement, after a penetration without shooting.</li><li>• Continued pressure play.</li><li>• Switching play (crossing and inter-positional changes).</li></ul>	<p>Receives ball moving, threatening goal, and seeks best decision:</p> <ul style="list-style-type: none"><li>• Attempts to get defender out of balance/position to beat him/her, by faking.</li><li>• If able to get into a high-scoring situation, adjust the type of shot to situational constraints.</li><li>• Having created advantage for teammates (two defenders were trapped), releases ball.</li><li>• If not able to break through, attempts to lead away opponent to make space, while protecting ball for a good pass.</li></ul>	<p>Adjust position/movement as needed in the flow of the game:</p> <ul style="list-style-type: none"><li>• Maintains wide-open positioning.</li><li>• Realises when to support ball handler, by moving away, backwards, or approaching or crossing.</li><li>• Gets into an open path to receive threatening to score.</li></ul>

### Designing learning tasks

Lead-up games (e.g., end-line handball, multiple goals game).

*Go-for-goal-tasks* (3v3, 2v2 and 1v1, with defensive pressure).

Game play 2v2 in the central sector, with supporters in half- and full-court.

Game play 2v2 in the side sectors (right and left), with or without supporters, in half- and full-court.



**Partial game forms** - examples of the learning tasks to work on the above-mentioned concepts and skills:

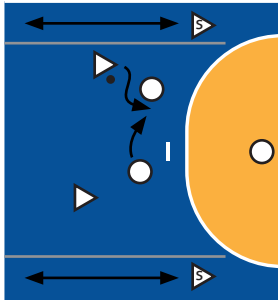

*Game play 2v2, with supporters in half or full court size.*

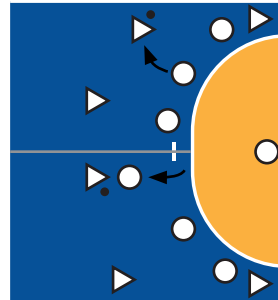

*Game play 3v3, per sectors, in half or full court size.*

**Remarks:**

**If learners struggle in creating space and attacking continuity**

Game play situations with numerical advantage are a good means to lead students to focus on employing spacing positions around goal-area line, making space and pressure play continuity to get an open scoring opportunity. Meanwhile, they will get used to counting defenders, being aware of how to trap them towards one side (making space) and pass the ball toward the opposite (where defenders are outnumbered by the attackers). Here it is very important to develop the ability to perform a side pass toward the same and the opposite side of throwing arm under pressure, particularly for the wing.

**Partial game forms** – examples of recommended learning tasks to work on the above-mentioned concepts and skills:

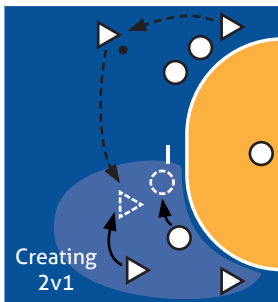

*Game play 4v3+GK around goal-area line, in half court. It can flow from 4v3 into 3v2, 2v1 and 1vGK.*

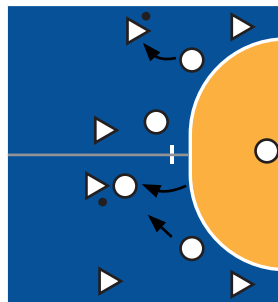

*Game play 3v2. Continued pressure play can flow from 3v2, into 2v1 and 1vGK.*

**Attacking the goal and shooting**

Now the greatest challenge is to outwit the defender with the ball, to penetrate into the space between defenders to attack the goal. It is very important that learners are aware of making space or ensure workable space before receiving or while approaching the defender (attacking the inward/outward and then change direction). When for some reason they receive the ball at a slow pace or while standing, they should learn to use a dribble-draw approach. Here, it is

very important for learners to practice different types of shots and from different positions, since it is not very likely that they will improve shooting skills only by playing.

The 2:2 defence will necessarily lead defenders to protect the space in front of the goal, meaning that attackers will be compelled to exploit more the outward space and to make joint efforts between the backs and wings. Now the task 2v1 around the goal-area line and at the side (right and left) can be very useful in developing these skills.

Tactical concepts/ skills	<i>On-the-ball skills</i>	<i>Off-the-ball skills</i>
<ul style="list-style-type: none"> <li>• Faking.</li> <li>• Dribble-draw approach.</li> <li>• Duels without ball (1v1).</li> <li>• Penetration-shooting.</li> <li>• Wing shooting.</li> <li>• Drawing defender to make space.</li> <li>• Passing to the wing.</li> </ul>	<ul style="list-style-type: none"> <li>• Makes space before receiving and attempts to beat defender (1v1).</li> <li>• Employ straight penetration or misdirection-penetration according to defender response.</li> <li>• Jump-shoots attempting to increase shooting angle to beat goalkeeper.</li> <li>• Inward attacking freeing the wing (solves 2v1).</li> </ul>	<ul style="list-style-type: none"> <li>• Apply body fakes/cutting moves to beat opponent, getting open to receive and attack goal.</li> <li>• Is ready to receive, threatening goal and to exploit the open space.</li> </ul>

### Designing learning tasks

1v1 with ball, with defender out of position or constrained.

1v1, in positional area and with supporter(s). 2v1 in width (around the goal-area line).

Shooting from the back and wing, with time-space advantage over defender.

### Regaining the ball and defending space

With the introduction of pressuring zone defence (2:2), students will develop an understanding of the concept of zone defence and still focus on getting the ball back for fast attacking. The concept of individual responsibility is now adapted to a zone of action. They will focus on learning to deny space through effective positioning, and to pressure the attacker with the ball and near attacker without the ball, avoiding being beaten (1v1). When attackers are becoming proficient in beating the pressuring defender, learners should be aware of reducing open space through shifting and coverage (including back-side help).

Tactical concepts/ skills	On-the-ball skills	Off-the-ball skills
<ul style="list-style-type: none"> <li>• Individual positional responsibility</li> <li>• Centre-forward and outside defenders</li> <li>• Backing up teammates</li> </ul>	<ul style="list-style-type: none"> <li>• Step up to close-out/tackle, denying penetration and shooting into spaces of great value (with wide-open shooting angles)</li> </ul>	Adjust position/movement as needed in the flow of the game: <ul style="list-style-type: none"> <li>• Exerts pressure to close off passing lane, dissuades or intercepts ball</li> <li>• Helps teammate if he/she is beaten to avoid opponent's open scoring attempt</li> </ul>

### Designing learning tasks

Depending on learners needs, it might be needed to focus more on defensive skills or not. Most often, these skills are learned during game play integrated with offensive tasks.

## 9.3 Advanced Level – Handball

4<sup>th</sup> stage: Transition to official sized court and and to full game 7v7

The transition from a small-sized court to a full-sized court may occur according to learners' readiness and school conditions. When moving to an official court, space increases greatly (three times bigger than a standard mini handball court), so it is essential to increase the number of players as well. Therefore, we recommend progressing to the 6v6 game form. Please note that the full version of the game (7v7) is much more space restrictive and complex, as there are two more players.

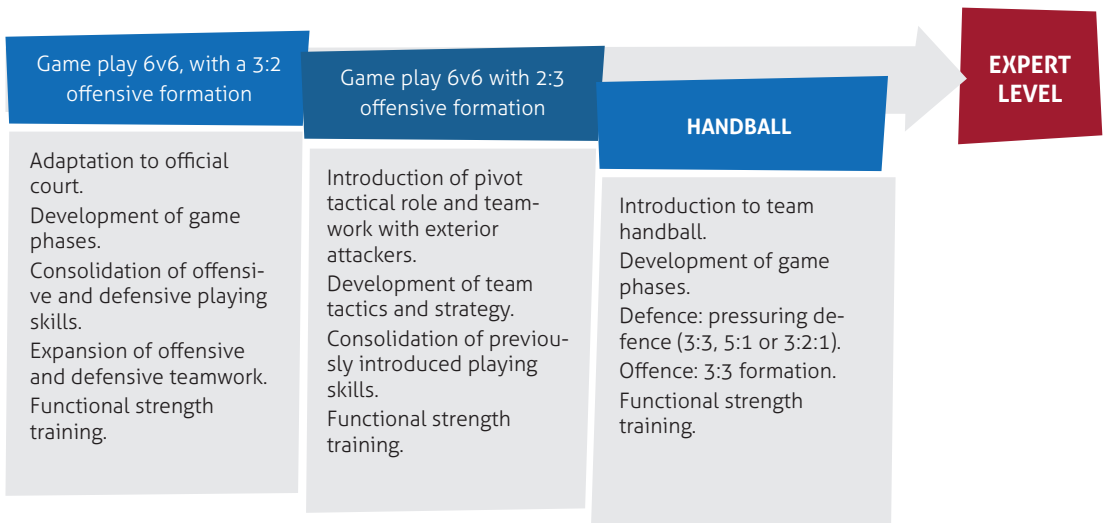

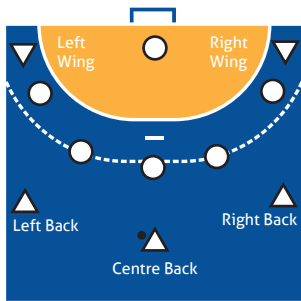

*Positional play with 3:2 offensive formation against pressuring defence*

**Recommendation:** introduce organisational rules in fast breaking/retreating play according to the configuration of the system and situational constraints to learners to play in different playing positions. Self-rotation rules to exchange goalkeepers should also be used.

**Remarks:**

If you do not have an official handball court, you can use alternative game forms (e.g., on the small-size court game play 4v3+GK, like beach handball; on the medium-size court game play 5v4+GK, with or without a pivot).

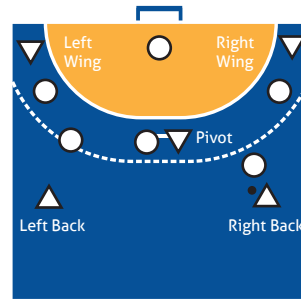

*Positional play with offensive transformation to introduce the pivot role (3:2 → 2:3)*

**Recommendation:** in each attack, a new player should run inside to play as pivot.

## 9.4 Assessment and Check Points

The major role of assessment is to provide information about students' achievements and their readiness to progress to a more demanding game form and to plan further learning activities for the students to explore and to improve their playing skills.

- ↳ What is performance in handball?  
What is a skillful player?
- ↳ Which goals and outcomes are to be assessed or graded?
- ↳ What kind of assessment will be used (traditional, authentic or both)?
- ↳ When does the assessment take place (diagnosis, continuous, formative or summative)?
- ↳ How will assessments be conducted?

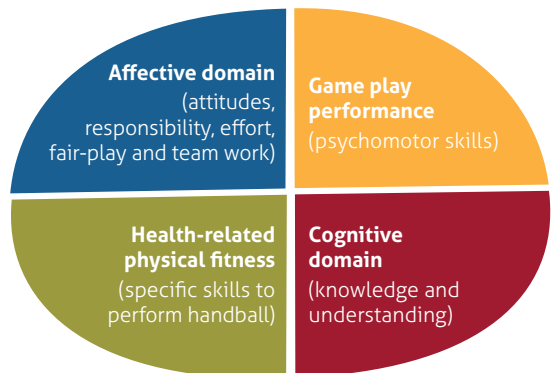

*Learning domains and domain interactions*

### **Principles about assessment for learning:**

- ↳ Share the goal and outcomes of learning with students.
- ↳ Make clear the criterion for success.
- ↳ Involve students in their own assessment (and of colleagues).
- ↳ Provide feedback to motivate students to improve their performance.

Most often, assessments are informal – checks for game play understanding, teacher’s observation as they play or just asking students how many balls they stole, how many open scoring attempts they achieved. If the assessment is more formal, the teacher must prepare specific assessment materials, set up the assessment, and allocate sufficient time for its completion. Here, we will only focus on the formal and summative assessment.

### **STANDARDISED SKILLS TESTS - Traditional approach**

This type of test usually involves static and artificial tests that measure a limited range of skills needed to play handball. That is, the skills are measured in a non-game situation. Teachers must be aware of what are the learning objectives and the test’s limitations for game play performance assessment. The front-wall passing tests or throwing a ball into a fixed target are examples of static tests.

### **AUTHENTIC ASSESSMENT - Performance assessment**

The game play performance assessment refers to the practice of making assessments that involve real-game play settings, problems, posing problems in which knowledge and playing skills taught will be applied. If the major goal is to teach how to play handball, then authentic assessment during a game is recommended to be used, not with a skills test in a non-game context. The key here is to focus on the students’ abilities (a combination of tactical-technical and motor skills) to solve situational game problems worked during classes. The assessment can be done while playing (BGF/PGF) or during a task (game-like) that represents a specific aspect of the game. In addition, the students’ game statistics can also be used to obtain some game play performance indicators.

#### **Remarks:**

If the PE teacher is not quite familiarised with the game, the main difficulty is to understand the internal game logic, such as game principles and tactical behaviours (team, group and individual). This is termed domain-specific knowledge. Another critical challenge is to be able to see what is going on, to read the game, and to identify beginners’ most critical difficulties. For those it might be useful to perform indirect assessment (through video images).

## Example for observation of students:

### Beginner form

STUDENTS' NAME	Attack		Defence	Teamwork and attitudes	Physical fitness	Global level	Notes
	On-the-ball skills	Off-the-ball skills					

**Note:** Performance level on a scale of 1 to 4 (in which 1 is poor, 2 fair, 3 good, 4 great).

### Beginner game play performance assessment rubric – Qualitative assessment

Game play competence	Game sense and competence in on-the-ball skills and movement patterns to successfully play with full-court pressure			
	Poor 🏠	Fair 🏠🏠	Good 🏠🏠🏠	Great 🏠🏠🏠🏠
<b>ATTACK</b>  Decision-making (with ball) + Support + Execution	Is unable to create advantage  <b>On-the-ball skills</b> - Loses ball when under pressure (bad decision or technique deficits) - Takes too much time to penetrate when an opening arises (loses advantage)  <b>Off-the-ball actions</b> - Lack of space and body awareness to evade opponent - Is unaware of making space and to support teammates under pressure	Is unable to create advantage most of the times  <b>On-the-ball skills</b> - Struggles in maintaining ball under pressure (slow and predictable passes) - Recognises free teammates and releases ball  <b>Off-the-ball actions</b> - Struggles in making space and to support teammates under pressure - Evades opponent sporadically	Is able to create advantage  <b>On-the-ball skills</b> - Passes ball successfully under pressure - Receives ball moving, threatening to score, and jump shoots with appropriate motion - Assists an open receiver to score  <b>Off-the-ball actions</b> - Uses space effectively to make forward progression and to attack goal - Adjust position as needed by the flow of the game	Is able to create advantage consistently  <b>On-the-ball skills</b> - Appropriate decision-making (passing, faking, dribbling or shooting) - Beats defender in open spaces (1v1) - Is able to free teammates to score  <b>Off-the-ball actions</b> - Creates new paths of action - Gets easily open by timely employing cuts/fakes
	<b>DEFENCE</b>	Hardly plays individual marking  Poor basic defensive positioning	Understands individual responsibility concept  Tries to keep individual marking	Recognises his/her roles immediately after losing ball Plays individual marking consistently without making fouls
<b>Teamwork and attitudes</b>	Blames teammates Disrespectful behaviour (with referees) Needs supervision to stay on task	Occasionally breaks the basic rules Accepts referee decision	Plays within rules Exhibits self-control Shows good sportspersonship and fair play	Inspires classmates Shows reliable leadership Supports classmates and helps them to improve

**Note: Advanced/expert levels** - In clubs, the observer goes even deeper, using statistics of player and team activities to assess development. In recent years, a video analyst plays a major role in this function, creating a database of individual player activities, team tactics and strategies, and all the data are associated with adequate statistics.

## Health-related physical fitness

Handball can be a valuable tool for the promotion of health and healthy lifestyles. From this point of view, it is reasonable to describe here a possible set of tests to evaluate the progress of physical conditioning promoted by the sport. Of course, health also includes mental health (self-confidence, happiness, socialisation, etc.), and this cannot be evaluated by these tests. So, remember that this focuses only on the conditional aspects of fitness, and that many other tests besides the ones provided here could also be adequate for this purpose.

A motor test (or test battery) is the most commonly used diagnostic method for determining the level of motor skills (performance). Motor tests must ensure test reproducibility, test verifiability (known as Test Quality Criteria), and include a developed scoring system. In different countries, different test systems are used to determine the level of motor skills in handball. However, testing has the same goals, and it is the inclusion of tests that closely match the level of motor skills needed to achieve optimal performance in the game.

Testing is primarily used to determine player strengths and weaknesses, so as to design the most appropriate handball conditional training programme. For example, assessment of lower limb power and strength asymmetry might be useful to identify players with severe bilateral asymmetries and strength deficits, which can be useful when designing individual training programmes for injury prevention and performance.

Another use of testing is for talent identification, to direct the player to be better suited in the group, to play in a more appropriate position or to compete at a more appropriate level.

The following are examples of simple fitness tests which can be easily reproduced on field and measure strength, power, cardiorespiratory function, anaerobic capacity, agility and body composition (weight, height and Body Mass Index).

	Rubrics	Assessments/tests
	<b>Body composition</b>	Weight, height and Body Mass Index
<b>Motor skills</b> (key components)	Lower body strength and explosive power	Standing long jump   Single hop test (complementary)   Triple hop test (complementary)   Vertical jump test
	Upper body strength, power and endurance	Overhead medicine ball throw (forwards)   Press-up test
	Multidirectional movement (forward, lateral, and backward) test	Agility T-Test (Sassi et al, 2009)
	Maximal aerobic function, anaerobic capacity, neuromuscular and change of direction qualities, and inter-effort recovery	30-15 Intermittent Fitness Test (Buchheit, 2008)
	Strength and endurance of the abdominals and hip-flexor muscles	Sit-up test

---

**Standing long jump:** the task is to jump as far as possible, landing on both feet without falling backwards. The student stands behind a line marked on the ground/floor with feet slightly apart. A two-foot take-off and landing is used, with swinging of the arms and bending of the knees to provide forward drive. The distance is measured from the start line to the heel of the landing leg. Three attempts are allowed. Record the longest distance jumped.

**Single hop test:** the task is to jump as far as possible on a single leg in a balanced manner. The distance is measured from the start line to the heel of the landing leg. Three attempts are allowed. Record the longest distance jumped. The jumping technique can or cannot use a countermovement.

**Triple hop test:** the task is to jump as far as possible on a single leg three consecutive times, in a balanced manner. The distance is measured from the start line to the heel of the landing leg. Three attempts are allowed. Record the longest distance jumped.

**Vertical jump test:** student stands side on to a wall with the hand raised up, and keeping the feet flat on the ground/floor, then mark the highest point he/she can reach. Afterward, the student stands away from wall and one foot jumps attempting to touch wall at the highest point of the jump. The difference in distance between the standing reach height and the jump height is the score. The jumping technique can or cannot use a countermovement. The best of three attempts is recorded.

**Overhead medicine ball throw (forwards):** The size and weight of the medicine ball depends on the age group being tested. The student stands at a line with the feet side by side and slightly apart, and facing the direction to which the ball is to be thrown. The throwing action is similar to that used for a soccer/football sideline throw-in. The ball is held with the hands behind the head, and then thrown vigorously forward as far as possible. The student is permitted to step forward over the line after the ball is released. Three attempts are allowed. The best result of three throws is recorded.

**Press-up test:** Perform as many press-ups as you can without rest. This test measures the endurance of the upper body muscles.

**Sit-up test:** As above, perform as many sit-ups as possible without rest. Be sure to define beforehand what counts as a sit-up! This process of fatiguing a muscle (or muscle group) to measure its endurance can be repeated with any body part.



**30-15 Intermittent fitness test** (Buchheit, 2008): was developed to more closely replicate the demands of intermittent sports, like handball, when compared with other standard beep tests.

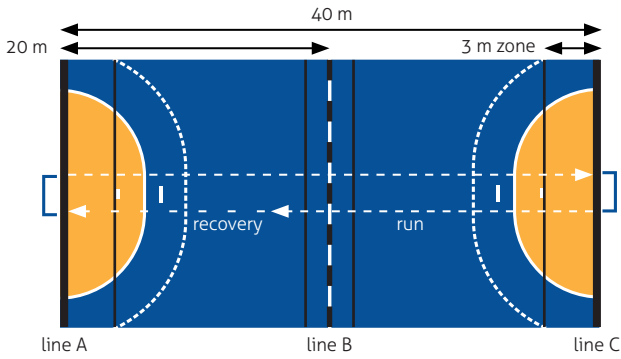

The 30-15 IFT consists of 30-second shuttle runs interspersed with 15-second walking recovery periods. The test starting speed is 8 km/h (e.g., first 30-second shuttle run), and this speed increases by 0.5 km/h for every 30-second stage thereafter. So, the running speed at stage 1 is 8km/h, stage 2 is 8.5km/h, stage 3 at 9km/h and so on.

**Agility T-test** (Sassi et al, 2009):

Set out five cones as illustrated.

The student starts behind the start line (cones A).

When the timer starts, the student sprints to cone B and touches the base of the cone with the left hand. He/she then turns right and shuffles sideways to cone C, and also touches its base, this time with the right hand. Then, the student shuffles sideways to the left to cone D and touches its base with the left hand. He/she then shuffles back to cone B, touches it with the right hand, and runs backwards to cone A. The stopwatch is stopped as he/she crosses the finish line. Three trials are recommended with a few minutes of recovery. Take the fastest time.

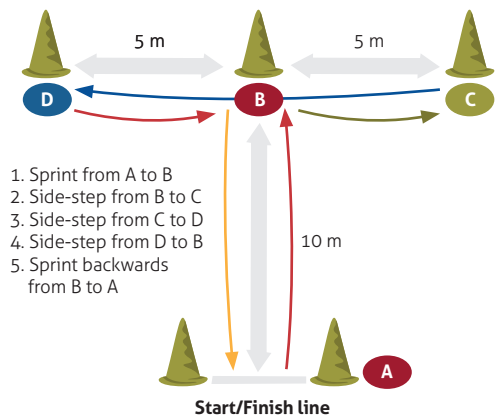

1. Sprint from A to B
2. Side-step from B to C
3. Side-step from C to D
4. Side-step from D to B
5. Sprint backwards from B to A

**Note:** If you do not have a table with norms of fitness test, you can interpret the results among your group or with the previous generation as they have the same age and sex.

---

## 9.5 Selecting and Long-Term Talent Development

The recruitment of the most talented young handball players is a key strategic aspect for the development of handball in all countries, but as experience and science suggests, it is very hard and risky to predict the future best players from very young ages.

Handball is an extraordinary collective game because it includes players of various somatypes, heights and weights. Throughout history it has been proven that even players with a non-typical anthropometric profile can achieve elite level performance. Becoming a successful player in handball is the result of a multitude of factors.

Part of the problem in predicting future outcomes stems from the fact that youth coaches often confuse talent selection, which simply assesses the best players on the court today, with talent identification. In fact, it is very problematic to identify the critical traits to become a successful handball player and to assess them at young ages, because some players enjoy the benefits of puberty before others. This problem persists throughout all youth sports and necessitates the involvement of all parties, including teachers, coaches and administrators, if we wish to solve it.

**Note:** *According to the latest statistics, 70% of kids drop out of organised sports by the age of 13.*

Talent identification requires the training of a larger number of players over a greater period of time. Identifying talent also places a higher demand on coaching, developing the skills to assess all the physical, physiological, psychological and technical factors of a complete player, understanding the essence of what is required of athletes to become elite handball players. A continued focus on talent selection at the youth level stymies the growth and popularity of the sport and undermines the development of elite handball players after puberty.

### Key recommendations for talent development

Therefore, we must **stop cutting youth players**, allowing all players to graduate through the different levels of game play provided in this book, **develop a holistic approach** that sees the development process as individualised and not fixed throughout puberty, **better educate PE teachers and coaches** (e.g., cooperation with education system in the country and home federation), and **at the youngest ages focus on festivals and leagues** (e.g. cooperation among schools, clubs and regional associations of schools events), as we detail below, and delay national competitions till after all players have finished puberty.

In the end, our teams, schools and clubs will greatly benefit from this approach, as they will have a larger pool of better talent from which to select, and because we have fostered a player-focused environment that extends sport participation through puberty, our kids will be healthier and well-rounded.

Handball deserves to be added to all physical education curriculum. It is played by youngsters worldwide in their free time or in schools. New tendencies in physical education focus on physical activities and sports which can be played for a lifetime. Handball is a complete sport, developing agility, strength, power, speed, balance, flexibility cardiovascular endurance, body coordination (asymmetrical and symmetrical movements), etc. Handball can be played recreationally or competitively and is easy to teach and fun to play.

This handball curriculum offers PE teachers and coaches a structured, balanced programme of work. This chapter is based on the practice and improvement of skills through small-sided, PGF, and BGF games, the so-called game-based approach. The main focus of this programme is on understanding game principles such as using open space, creating an opening, improving the decision-making process, etc.

The teaching environment and constraints may be quite different from one school to another, and from one region or country to another. The quality and quantity of the facilities (with proper handball courts and goals), the amount of specific balls for handball initiation, the size of the class, and the time available for lessons play an important role in effective handball teaching. Each country must have the freedom to play and promote mini handball and handball according to its own resources and requirements!

The successful implementation of handball at school PE curriculum will be dependent on effective planning by PE teachers, coaches and schools. Developing a basic handball programme in the school can be the beginning of a great evolution of this sport in your region, department and/or country.

### ***A wide, balanced handball at school programme should:***

- ↪ Be in accordance with the needs of a school.
- ↪ Respect the principles and standards of education in the country.
- ↪ Provide the curriculum with step-by-step teaching process.
- ↪ Recommend basic guidelines for different levels of students.
- ↪ Include the organisation and active participation in handball at school events.

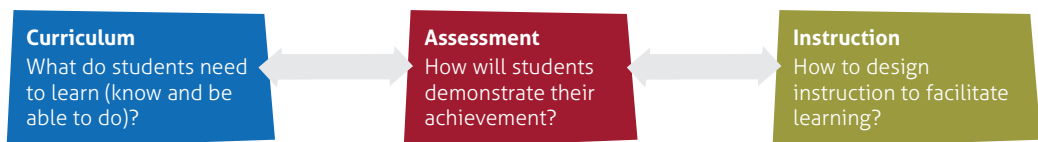

Generally speaking, there are numerous and divergent situations that each PE class should be able to approach and cannot all be easily addressed. So, our main purpose is to present general guidelines concerning the most standard situations.

## 10.1 Novice School Curriculum

### Mini handball with unstructured defence (corresponds to 1<sup>st</sup> stage in the teaching process)

Tactical problems	Decisions and Movements	Skills
<b>Attack/Scoring</b>		
<b>Maintaining ball possession</b> <i>Game forms with uneven numbers (4v3+GK or 3v2+GK); passing games (2v1/3v2/4v3)</i>	Makes joint efforts to retain ball possession (inter-passing and give-and-go actions): <ul style="list-style-type: none"> <li>• passes ball only if the teammate is free and in an open passing lane, adjusting the type of pass;</li> <li>• moves toward free space and gets open to receive the ball.</li> </ul>	Receiving-passing while running in different directions and distances. Makes the pass catchable/receivable. Executes an overarm and bounce pass. Steps to catch ball and adjust position/movements for a successful ball reception.
<b>Making forward progression</b> <i>Game forms with uneven numbers (4v3+GK or 3v2+GK)</i>	Recognises when to pass or to make progression dribble. Adjusts actions as needed in the flow of the game: <ul style="list-style-type: none"> <li>• adopts a spread-out (open) positioning;</li> <li>• breaks alignment with defender and gets into an open lane to receive the ball.</li> </ul> Having passed the ball, continues moving.	Receiving-passing while running forward. Catches ball with one running step, pointing to goal and forms arm-throwing position. Executes a lead pass to an open receiver ahead. Ability to bounce ball into different directions.
<b>Attacking the goal</b> <i>PGF 2v1+GK with open space</i>	Having received ball, squares up to goal Realises when an opening arises and takes the open shot; passes ball if defender reacts and blocks the opening. Maintains good spacing from the attacker with ball and gets open to threaten goal. Realises and anticipates advantage (2v1 in wide-open space) and gets ready to receive a pass to attack the goal.	Executes set shooting in a balanced manner with appropriate arm-throwing motion. Shoots stepping forward onto the opposite foot to the throwing arm. Ability to integrate cycle of steps with throwing (inter-segment coordination).
<b>Defence/Preventing Scoring</b>		
<b>Regaining ball possession and protecting the goal</b> <i>All defensive situations</i>	Immediately after losing the ball, gets between the attacker with ball and the goal. Is active and watches for ball interception. Understands the goalkeeping role and puts ball into play fast, finding a safe passing lane.	Spatial/directional awareness and motor abilities. As goalkeeper: <ul style="list-style-type: none"> <li>• adopts the basic goalkeeping position to protect the face/head and to save the ball;</li> <li>• executes the basic saving technique, catching the ball and makes good passes to court players.</li> </ul>
<b>Starting/Restarting Play</b>		
<b>Throw-off</b> <b>Throw-in</b> <b>Free throw</b> <b>Goalkeeper throw</b>	Positioning. Basic rules application with supporting positions.	Initiating play. Putting ball into play.

## 10.2 Beginner School Curriculum

**Mini handball with individual defensive responsibility** (corresponds to 2<sup>nd</sup> stage in the teaching process)

Tactical problems	Decisions and Movements	Skills
<b>Attack/Scoring</b>		
<b>Maintaining ball possession</b> <i>Mini handball with full-court pressure; passing games with individual marking (2v2/3v3/4v4)</i>	Chooses and accurately passes the ball to the best positioned attacker, preferably free. Supports the passer by faking the defender and moving, cutting into open spaces to receive the ball.	Inter-passing against close pressure. Ability to fake, dodge and, then, accelerate fast to get away from defender. Moves feet fast and adjusts body segments in relation to flight pathway of the ball for a successful catch and continues smoothly the offensive actions.
<b>Making forward progression</b> <i>Mini handball with full-court pressure; PGF 2v2/3v3+GK with supporters in half and full court</i>	Switches fast from defence to offence to exploit possible situational advantage to get an easy scoring – fast breaking play. Makes joint efforts against close pressure to build up play from the back, creating advantage in wide-open space: <ul style="list-style-type: none"> <li>• With ball, adjusts actions as needed in the flow of the game:               <ul style="list-style-type: none"> <li>- With pressure, protects the ball and looks for an open receiver; if the defender is in the passing lane, uses fake passes.</li> <li>- Having space and without an open teammate, plays one-on-one.</li> </ul> </li> <li>• Without ball, spreads out the attack and evades opponent (1v1) by using misdirection and cutting moves.</li> <li>• Having passed the ball, cuts to receive a pass (gives-and-goes in depth) and if doesn't get the ball, repositions (replacement cuts).</li> </ul>	Executes a lead pass over different distances and from different directions to a receiver running forward. Catches ball and follows through by smoothly moving the ball into position to immediately shoot, pass or dribble. Ability to beat opponent (duels without ball) by using several forms of misdirection and cuts. Uses fake pass to put the defender off balance, allowing getting into an open path to progress by using cycle of steps and dribbling.
<b>Attacking the goal</b> <i>PGF 2v2+GK with supporters in half and full court</i>	Finds space to prepare ball reception, squaring up to goal and seeks best decision: <ul style="list-style-type: none"> <li>• Having advantage, penetrates toward goal;</li> <li>• Having an open teammate, better positioned, passes ball.</li> </ul> Without ball, knows where to move to make space, when to give support and to fake defender to get open to attack the goal.	Faking with ball (duels) in wide-open spaces. Ability to support ball handler, by moving away, backwards, or approaching or crossing. Gets into an open path to receive, threatening to score.
<b>Defence/Preventing Scoring</b>		
<b>Regaining ball possession</b> <i>All defensive tasks</i>	Switches quickly from offence to defence and identifies direct opponent; remains with the assigned player unless another attacker is about to score. Employs close pressure when the assigned player has the ball, denying progression and shooting. Keeps the opponent in front of him/her, being aware of ball location to intercept the pass; if beaten, immediately gets back to help teammates or to track the lost attacker.	Individual defensive responsibility. Close marking ability. Watches for ball interception. Stealing ball without body contact.
<b>Starting/Restarting Play</b>		
<b>Throw-off</b> <b>Throw-in</b> <b>Free throw</b>	Positioning. Basic rules application with supporting positions.	Initiating play. Putting ball into play systematically.
<b>Goalkeeper throw</b>	As a goalkeeper puts ball into play fast, realising when to choose an open receiver close by or further ahead (straight forward pass).	Executes straight forward passes to the shooter.

## 10.3 Intermediate School Curriculum

### Transition to handball and to pressuring zone defence with positional responsibility

(corresponds to 3<sup>rd</sup> stage in the teaching process)

Tactical problems	Decisions and Movements	Skills
<b>Attack/Scoring</b>		
<p><b>Maintaining ball possession against positional pressure</b></p> <p><i>Game form (5v5 or 6v6, on small or medium-sized court)</i></p> <p><b>Solving outnumbered positional play</b></p> <p><i>2v1/3v2/4v3+GK, around goal</i></p>	<p>Makes joint efforts to maintain a balanced attack and ball circulation around goal:</p> <ul style="list-style-type: none"> <li>• If pressured, protects ball-throwing arm and attempts to draw away opponent to make space and seeks for a safe passing lane; after having released the ball to a teammate, readjusts position as needed by the flow of the game;</li> <li>• Away from ball side, keeps a wide-open position;</li> <li>• Without ball, realises when to support the attacker with ball, by moving away, backwards, or approaching or crossing;</li> <li>• Recognises advantages (2v1/3v2/4v3) employing pressure play and wide attacking play concepts.</li> </ul>	<p>Inter-passing skills under positional pressure.</p> <p>Executes side pass toward the same and the opposite side of throwing arm (over-arm and wrist pass).</p> <p>Receives and passes quickly.</p> <p>Ability in moving forwards/backwards and sideways after a penetration attempt.</p>
<p><b>Breaking through pressuring zone defence (2:2) and attacking continuity</b></p> <p><i>Game form (5v5 or 6v6, on small or medium-sized court)</i></p> <p><i>Positional play 2v2/3v3+GK in sector with/without supporters in half and full court</i></p>	<p>Makes joint efforts to create numerical advantage:</p> <ul style="list-style-type: none"> <li>• Keeps workable space and realises when to start run approach to receive ball (with/without initial misdirection) to initiate pressure play; having received the ball employs fake actions with ball if needed to create advantage over the opponent (1v1); having trapped two defenders, releases ball;</li> <li>• Without ball recognises the situation, works to ensure pressure play continuity, by getting into an open path to receive, threatening goal or employing switching play concepts (crossing or inter-positional changes).</li> </ul>	<p>Ability to employ initial misdirection run approach (away from attacker with the ball).</p> <p>Ability to fake with ball in reduced/tight spaces: fake passes, fake shots and misdirection penetration (inwards/outwards)</p> <p>Side-stepping ability.</p> <p>Penetration shooting from the side (back and wing).</p>
<p><b>Attacking the goal</b></p> <p><i>Positional play 2v2+GK in side sectors (right and left) with middle supporter</i></p>	<p>Attacker with ball fakes action facing defender (1v1) to create an opening for him/herself or forces the next defender to over-commit, freeing the teammate and assisting him/her.</p> <p>Attacker without ball ensures workable space and starts timely run approach to receive to initiate pressure play (1v1).</p> <p>When able to get into a high-scoring situation, adjusts the type of shot to situational constraints.</p>	<p>Ability to employ fake actions with ball, dribble-draw approach, etc.</p> <p>Passes to the wings consistently.</p> <p>Ability to shoot from the wing – opening the shooting angle.</p>
<b>Defence/Preventing Scoring</b>		
<p><b>Regaining ball possession</b></p> <p><b>Defending space</b></p> <p><b>Two-line zone formation</b></p> <p><i>In all defensive tasks</i></p>	<p>Employs individual responsibility adapted to a zone of action, focuses on denying space in high scoring areas/positions.</p> <p>Defender of the attacker with ball steps up to close-out/tackle, denying penetration and shooting into spaces of great value (with wide-open shooting angles).</p> <p>Supporting defenders are active, pressuring near receivers to provoke offensive mistakes and to regain ball to counterattack fast.</p> <p>Gives support-cover to the pressuring defender, and helps if he/she is beaten, avoiding opponent's open scoring attempt.</p>	<p>Basic position against attacker with ball (staggered feet, closing dangerous attacker's side and hands ready for action).</p> <p>Executes quick footwork, slides and runs (forward/backward and sideways).</p> <p>Ability in contact marking (1v1)</p> <p>Spatial-temporal and directional awareness.</p>
<b>Goalkeeping</b>		
<p><b>Basic roles</b></p>	<p>Positioning and moving to cover the goal and close down the most dangerous shooting angles. Is aware of how to respond to a wing shot.</p>	<p>Ability to step to the side and sliding.</p> <p>Executes the basic stance/save near the post against wing shot.</p>
<b>Starting/Restarting Play</b>		
<p><b>Throw-off</b></p> <p><b>Throw-in</b></p> <p><b>Free throw</b></p> <p><b>Goalkeeper throw</b></p>	<p>Positioning.</p> <p>Supporting positions.</p> <p>Fast break situations.</p>	<p>Improved quality of game play.</p> <p>Putting ball into play with taking risk in the situation.</p>

## 10.4 Advanced School Curriculum

Handball (5+GK v 5+GK / 6+GK v 6+GK), corresponds to 4<sup>th</sup> stage in the teaching process

Tactical problems	Decisions and Movements	Skills
<b>Fast breaking play</b>		
<b>Making forward progression</b> <i>Game form (6v6, on medium-sized or official court)</i> <i>Full game (7v7)</i>	Understands the waves concept in a large-sized court and tactical roles in fast breaking play. Realises when to decrease the pace and rhythm of passing to build up attack phase.	Ability to generate action (with/without ball) according to tactical role, within fast breaking lines (waves). Executes accurate passes over different distances (short and long range) and from different directions to a receiver running forward.
<b>Positional play</b>		
<b>Maintaining ball possession against positional pressure</b> <i>Game form (6v6, on medium-sized or official court)</i> <i>Full game (7v7)</i>	Maintains good spacing on a large-sized court and understands the tactical roles according to playing position (wings, playmaker, backs and pivot). Makes joint efforts to maintain a balanced attack around goal and attacking continuity against pressuring defence, by employing switching play concepts (crossing or inter-positional changes) and ball circulation. Realises situations of numerical disadvantage on ball side, taking actions to retain ball possession.	Inter-passing skills under positional pressure with increased distance between passer-receiver. Ability to pass from different playing positions and to perform different types of passes according to situational constraints. Ability to generate action, movement according to the flow of the game.
<b>Breaking through pressuring zone defence and attacking continuity</b> <i>Game form (6v6, on medium-sized or official court)</i> <i>Full game (7v7)</i>	In 6v6 realises when to employ running inside manoeuvres to exploit the space behind the defensive line (exterior player runs to pivot position) or continued pressure play from the exterior. In a full game, recognises the constraints posed by systems with different line configurations (3:3, 5:1, 4:2 or 3:2:1) and how to break through by employing individual-tactical skills and group-tactical solutions.	Skills to fake with ball in reduced/tight spaces: fake passes, fake shots and misdirection penetration (inwards/outwards). Ability to employ fast, accurate passes, under pressure. Ability to pass ball to the pivot in a timely manner. Employs group-tactical actions with higher intensity, variability and technical consistency.
<b>Attacking the goal</b> <i>Game form (6v6, on medium-sized or official court)</i> <i>Full game (7v7)</i> <i>PGF 3v2, with a pivot in positional areas</i>	Understands the pivot's tactical role and generates path of action in collaboration with exterior players: - As a pivot, works to get into shielding-receiving position and moves into open spaces to receive ball or to disrupt defensive organisation. - As an exterior player works according to pivot play, adjusting the attacking trajectory (inward/outward) to make space for the pivot or to exploit the defender's reaction to pivot play.	Ability to employ fake actions with ball to create space for the pivot. Ability to adopt a shielding-receiving position, duels inside the defence and shooting from the pivot position. Executes straight and misdirection turn to goal from the pivot position and takes a penetration shot.
<b>Defensive retreat</b>		
<b>Regaining ball possession and stopping or delaying the adversary's fast transition</b>	Is aware and recognises a situation of fast defensive retreat to prevent opponents' fast break. Employs full court pressure whenever it is more advantageous than immediate recovery. Retreating according to tactical roles, situational constraints and without losing visual control of ball and direct opponent.	Skills to employ individual defensive responsibility in wide-open spaces. Watches for ball interception to immediately counter-attack. Ability to steal ball without illegal body contact.

Tactical problems	Decisions and Movements	Skills
<b>Positional defence</b>		
<b>Defending the space and the goal</b> <i>Game form (6v6, on medium-sized or official court)</i> <i>Full game (7v7) with pressuring defence (3:3, 5:1, 4:2 or 3:2:1)</i>	In a 6v6 or full game understands different tactical roles according to the zone of action within the defensive organisation. Understands the concept of keeping defensive balance or, even, numerical advantage around ball, by employing individual skills and joint efforts (group tactics). Understands positional responsibilities and cooperates to delay/disturb the opponent's movements and actions, preventing attackers from breaking through into spaces of great value and forcing offensive mistakes.	Skills to employ an anticipatory defensive behaviour and steals ball without illegal body contact. Ability to employ face-to-face body contact and to cover pivot. Positioning to dissuade and to intercept passes between exterior players and towards pivot.
<b>Goalkeeping</b>		
<i>Goalkeeper against various field positions</i> <i>Fast break</i>	Understand the basic requirements for goalkeeping from various shooting positions: throwing angle, jump direction, shooting distance, arm-throwing position and movement, ball techniques, and timing of action. Is aware of judging and anticipating a shooting situation, without moving prematurely. Understands when to start off an immediate fast break or to control the pace of the transition.	Proficiency in moving in all directions and covering goal as much as possible with his/her body. Ability to make low, waist-level and high saves on both sides. Positioning behind the block and saving long-range/through shots. Saving a straight and lob shot. Proficiency in long passes.
<b>Starting/Restarting Play</b>		
<b>Throw-off</b> <b>Throw-in</b> <b>Free throw</b> <b>Goalkeeper throw</b>	Improving the situation, surprise (fast throw-off).	Individual and group tactical improvement according to the situation.

Within this detailed framework, teachers can seamlessly integrate a handball curriculum into their PE classes, build successful programmes in their schools and districts, and have the confidence to do so without having any personal background in the sport. Whether you are beginning with youngsters or young adults, the developmental path is the same, the goal being to introduce, encourage and inspire the next generation of handball players to carry with them a love for the game and a passion for playing.



# 11. ORGANISATION OF HANDBALL EVENTS IN SCHOOLS



It is important to organise social and competitive events to further the development of students, giving them an opportunity to compete and enjoy handball outside of the classroom, all the while promoting the sport to the community. Whether festivals, tournaments or leagues, these events are important for child enjoyment, teacher and coach development, and community outreach, and should be considered essential parts of your handball curriculum.

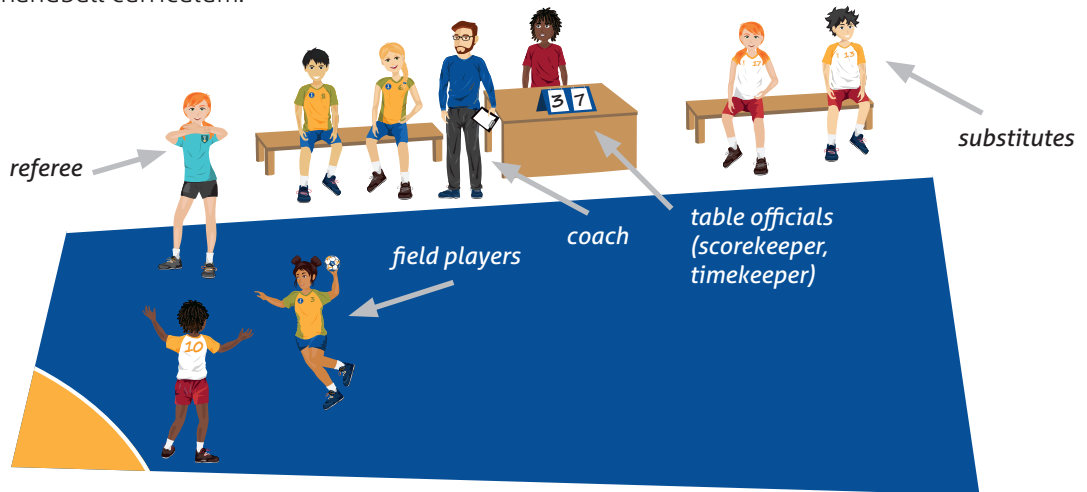

## 11.1 Festivals

A festival is a celebration of the sport and is a key component in establishing a successful Handball at School programme. Although winning is the basis of the games and mini-games played within festivals, the emphasis of a festival is placed on our core philosophy of fun, passion, and health, all of which are essential to a child's mental and physical development across the lifespan. Great care should be taken to ensure that the community and not the individual, or small group, is the focus of the festival, providing opportunities for recreational, developmental and elite players.

Festivals provide a great opportunity to further staff development, by offering concurrent trainings and interaction rituals for teachers and administrators to discuss curriculums and discover solutions to common problems experienced in their schools.

### CONFIGURATION

Festivals can be played indoors, outdoors or a combination of the two. Teams can be comprised of different genders, backgrounds and skill levels, with the emphasis on playing together and working together, no matter the outcome. Individual and small group technical and tactical games, such as a skills competition or mini-game duel, can be a great way to incorporate the students' favourite curriculum into the festival, and the rules can be adapted for different playing surfaces and varying space needs.

## EXAMPLES OF FESTIVALS

### School-wide Festival

A school-wide festival is a great unit-end event and requires the least amount of administrative work, because the teacher has greater control over resources, e.g., gym or field space, time, and equipment.

### District-wide Festival

District-wide festivals are excellent opportunities for teachers and administrators to come together to promote the sport, and because curriculum is typically controlled at this level, there is a natural continuity between the schools within a district.

### City-wide Festival

A city-wide festival requires a large public space, i.e., a park, community centre, or facilities at a secondary school, and will take considerable coordination to administer.

## ADMINISTRATION

Festivals require a minimal amount of administration, usually a few teachers and a small group of easily-trained volunteers to help keep the event moving along, the mini-games organised, and the games officiated. This is especially true of school- and district-wide festivals. Parents are a great community resource for festivals, and establishing a coordinator amongst them should be considered a priority.

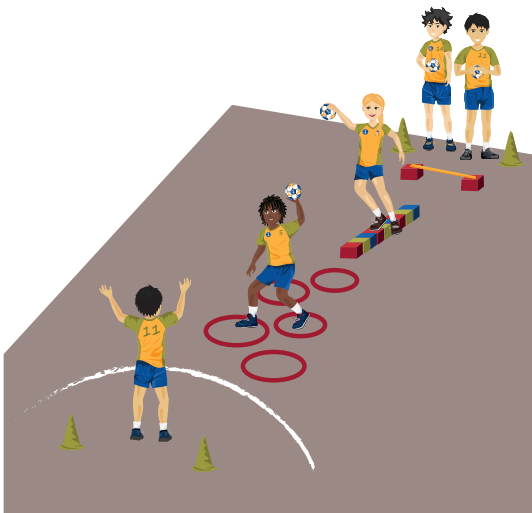

Festival stakeholders will include teachers, physical education coordinators, academic and sport administrators and parent-teacher organisations, and at the city-wide level, will require community and governmental support.

## PROBLEM SOLVING

### Not Enough Space

This is a common problem for festivals, and solutions to this problem can be found by adjusting the size of the individual courts and their relative parts, e.g., goal size, goal area, length, width, etc., reducing the number of players per team, shortening the length of the games, or reducing the number of games.

### Not Enough Time

You cannot do it all, so time will be a definitive factor in planning a successful festival. In the end, it is better to have a well-run 90-minute festival than nothing at all, so plan accordingly, and always remain focused on the quality of the event.

### Not Enough Staff

Staffing is a common problem for all new programmes, and festivals provide the flexibility to design an event that suits your staffing needs. Remember, the success of the event depends on smooth administration, so it is better to do well with what you have than to try to do too much with too little.

## 11.2 Tournaments

A tournament is a great unit-end event that tests the development of individuals, small groups, classes and/or schools against the development of other similar groups. Handball tournaments are competitive in nature, and as such, require greater control over space, administration, officiating, and time. The emphasis for tournaments is on competition, which is key to developing children's individual and group problem solving skills. Tournaments offer a great opportunity for professional development by establishing clear guidelines for participation in corresponding levels (see below). They also can be a source of funding for new handball equipment, increased staffing, and travel for future playing purposes.

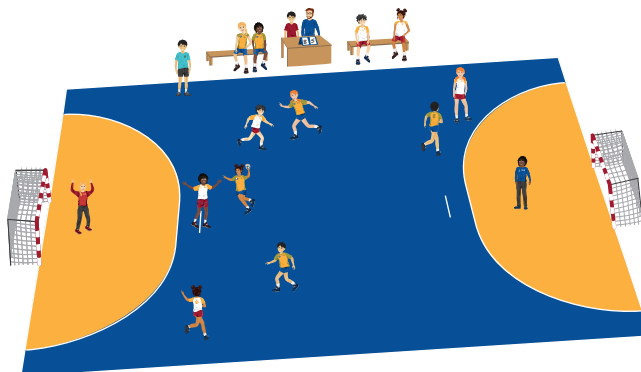

## CONFIGURATION

Tournaments can be arranged along the talent-interest spectrum, from recreational to developmental to elite, or they can be open, and welcome all groups without expectation of meeting or exceeding a certain category. When organising a tournament, it is important to properly classify the expectations for each category or sub-category within them, to control the quality of the game and the enjoyment of the players. With new programmes, tournaments will often be more open-style, comprised of a mix of interest and talent levels, and over time will become more particular to categories and sub-categories as performance will reflect recruitment, technical and tactical training, and teacher and player investment, with developmental and elite players committing the most time and effort to the tasks in class and during an event.



## EXAMPLES OF TOURNAMENTS

### School-wide Tournaments

School-wide tournaments can be grade specific, or pair children based on similarities, e.g., ages, genders, developmental milestones, etc. Teams can be self-selected, or they can be assigned.

### District-wide Tournaments

District-wide tournaments offer the best incentive for competition and should be considered a valuable stage for the winners of school-wide tournaments to be rewarded for their hard work and to continue their training efforts.

### City-wide Tournaments

City-wide tournaments are a great way of bringing together district-wide winners, supporting the work of the teachers who have excelled in the class and on the court, and rewarding cultures of excellence.

**Note:** For information regarding tournament format, results, and facility division, see pages 118-119.



## ADMINISTRATION

Tournaments require greater control over continuity of play and rule governance, and therefore, require commonalities across all performance-based factors, e.g., playing surface, court size, equipment, and officiating. By establishing a basic competition committee to organise facilities, coordinate competition structure, and train and certify referees and table officials, a tournament can be an important culminating event for all curricular programmes. Tournament stakeholders include teachers, team leaders or coaches, players, referee committees, tournament officials, physical education coordinators, academic and sport administrators, and parent-teacher organisations.

## PROBLEM SOLVING

### Not Enough Referees and/or Table Officials

At this level of the sport, volunteers can be easily trained to perform referee duties and table official duties, and students can be trained to play roles, too.

### Not Enough Space

Space is a determining factor in all tournaments, and while modifications can be made to include more or less teams or players at this level, it is important that the spirit of the game is not ruined by such decisions.

### Not Enough Time

Games can be lengthened or shortened to accommodate most schedules, but care should be taken to ensure that the quality of the games being played remain within player expectation.

## 11.3 Leagues

A league is a great unit-long event that requires regular space and staffing needs. Leagues are a proving ground for a student's work during class, and can provide a great incentive for hard work and dedication throughout the unit. A teacher or a small group of teachers can easily coordinate and administer a unit, using space already available to them and time closely aligned with the school day.

## CONFIGURATION

Leagues can be based on many selection factors, including grade-level, gender, talent-interest, and developmental considerations. Leagues can easily run before and/or after school, and require the least amount of oversight as a single teacher or a small group of teachers can officiate the games. At this level, teams can be self-selected, or assigned, depending on the needs and desires of the programme.

---

## EXAMPLES OF LEAGUES

Grade-based leagues can be mixed or aligned by gender and be configured in many ways to suit your needs. For example, a four-week before-school league for 50 students can be easily broken into four mixed teams, with each team playing nine games (three games against each opponent), leaving the final two days for third-place and championship games. This format requires only one game to be played each morning before school, which can be easily run by one teacher, performing referee and 'official' duties at the same time.

## ADMINISTRATION

Leagues require minimal administration, although working together with the school to accommodate the daily schedule will require some effort on the stakeholders' parts. League stakeholders will include teachers, physical education coordinators, academic and sport administrators and parent-teacher organisations.

## PROBLEM SOLVING

### Too Many Students

Leagues require the greatest amount of problem solving and decision making, as constraints on time and space limit the number of participants. For example, a school of 500 students, ages 6-12, cannot offer leagues for all their students. Therefore, creating a league to meet the most developmentally appropriate group, which in this case would be children aged 10-12 years, is a satisfactory solution to this problem.

### Too Little Extracurricular Time or Availability

Competition with other school extra-curricular programming, or constraints on player availability, can be limiting factors in the viability or sustainability of a league. A solution to this problem can be to play league games during PE classes throughout the unit, which can be a solution to the above-mentioned enrolment problem as well.

### Remarks:

Whether festivals, tournaments or leagues, it is important to offer students more access to competition, PE teachers opportunities for professional development, and communities greater access for involvement in youth sports. By hosting handball events, you are reinforcing our core values of fun, passion and health, and by doing so in combination with a teaching unit, you are building a proper foundation upon which our sport can be constructed in your school and beyond.

## 12. ACKNOWLEDGEMENTS



The authors of this booklet would like to thank Dr Hassan Moustafa for supporting development programmes such as Handball at School that strive to introduce, promote and expand the sport of handball around the world. We would also like to thank Amal Khalifa for her vision and tireless counsel throughout the formative and writing processes. For their contribution to the editorial process, we would like to thank Dietrich Späte and Dr František Táborský, as we could not have completed this booklet without the support, direction and commentary.

We are grateful for the unsung work behind the scenes, the commitment and dedication of the entire staff at the IHF Head Office in Basel, Switzerland.

For the PE teachers, coaches and administrators using this book, we sincerely hope that this Handball at School programme will transform your PE curriculum, inspire your students to be active throughout their lives, and create an entire generation of handball lovers. Of all the benefits this great sport has to offer children, none are more important than fun, passion and health.



## 13. REFERENCE

---

Bana, P., Späte, D., Lund, A., Strub, P., & Khalifa, A. (2011). *Teaching Handball at school, Introduction to handball for students aged 5 to 11*. International Handball Federation.

Buchheit, M. *The 30-15 Intermittent Fitness Test: accuracy for individualizing interval training of young intermittent sport players*. *J Strength Cond. Res.*, 22: 365-374, 2008.

Bunker, B. & R. Thorpe. *The curriculum model. Rethinking games teaching*. R. Thorpe, Bunker, D., & Almond, L. Loughborough, University of Technology, Loughborough: 7-10, 1986.

Czerwinski, J., & Táborský, F. (1997). *Basic Handball: Methods, Tactics, Technique*. European Handball Federation.

Estriga, L. (2019). *Teaching and learning handball: step-by-step. A teacher's guide*.

Hapkova, I. (2009). *Handball does not always mean Handball*. European Handball Federation.

Lund, J., & Tannehill, D. (2010). *Standards-based physical education curriculum development*. Burlington, MA: Jones and Bartlett Publishers.

Marczinka, Z. (2016). *Playing Handball: A Comprehensive Study of the Game*. Hungarian Handball Federation.

Rot, C. (2013). *Mini-Handball: A Guidebook for Building a Successful Youth Program*. University of Minnesota.

Sassi, R. H., Dardouri, W., Yahmed, M. H., Gmada, N., Mahfoudhi, M. E., & Gharbi, Z. *Relative and absolute reliability of a modified agility T-test and its relationship with vertical jump and straight sprint*. *J Strength Cond. Res.*, 23(6), 1644-1651, 2009.

Tannehill, D., van der Mars, H., & MacPhail, A (2013). *Building effective physical education programs*. Burlington: MA: Jones and Bartlett Publishers.

**More information can be found online in the IHF Education Centre:**  
<http://ihfeducation.ihf.info/>





## 14.1 Developing Scope and Sequence of Lesson Planning

	Main focus of the lesson	Structure of learning tasks
DAY 1	<p>Set up a challenging, enjoyable and safe learning environment to learn handball.</p> <p>Introduce or make a brief review about the primary rules (e.g., how to play ball, to score, to defend).</p> <p><b>Diagnosis assessment:</b> Identify students' level of performance and decide about the best game form to work on as a realistic and challenging handball game for the students.</p>	<p>Lead-up games</p> <p>Game play 3v2+GK</p> <p>Game play 3v3, with individual defensive responsibility or pressure</p>
DAY 2	<p>Interplay to keep ball possession: Pass and receive while running. Throwing and catching skills. To identify an open passing line. Ball handling and getting into throwing position.</p>	<p>Lead-up games</p> <p>Ball between two players (passing and moving)</p> <p>Possessing game 3v1 and 3v2</p> <p>Game play 3v2+GK</p>
DAY 3	<p>To recognise and to solve numerical advantage: when to shoot, to pass or to dribble. Support position in advance of the ball (moving away and ahead). Linking actions (running, receiving and shooting); three- and two-step cycle to shoot.</p>	<p>Lead-up games</p> <p>Possessing game 4v2 and 2v1</p> <p>Progression game play 2v1</p> <p>Game play 4v3+GK</p>
DAY 4	<p>To recognise when to progress/penetrate into the open space to shoot, to pass or to dribble. Give-and-go manoeuvres. Linking actions (running, receiving and shooting); three- and two-step cycle to shoot.</p>	<p>Lead-up games</p> <p>1vGK</p> <p>Game play 4v3+GK</p>
DAY 5	<p><b>Fair play and resilient spirit</b> Teamwork to set up a good scoring opportunity. Defensive retreat to protect goal and to regain ball possession.</p>	<p><b>Interclass competition</b> Game play GK+3v3+GK, with defensive pressure</p>
DAY 6	<p>To recognise when to play one-on-one without ball to create an opening. Cut and fake moves. Give-and-go manoeuvres. Unbalance defender and gap attack/penetrating into the open space.</p>	<p>Lead-up games</p> <p>Game play GK+3v3+GK, with defensive pressure</p> <p>Duels 1v1, with supporters</p>
DAY 7	<p>Tactical awareness on creating numerical advantage by playing with ball. To recognise when to track players and to look for pass interception.</p>	<p>Lead-up games</p> <p>Game play GK+3v3+GK, with defensive pressure</p> <p>Partial game form (2v2, with supporters)</p>
DAY 8	<p><b>Performance assessment</b> Identify students' level of performance.</p>	<p>Game play 3v2</p> <p>Game play GK+3v3+GK, with defensive pressure</p>

## PRO FORMA LESSON PLAN - SAMPLE

The structure outlined here is mainly recommended for pre-service and novice PE teachers. With growing experience, this can be done in a more flexible and compact manner. Here, the focus is only on the learning outcomes of handball lessons.

**Main learning objectives:** to develop tactical awareness of spreading out attack for fast ball advance to create an open scoring opportunity; to improve shooting skills (set and jump-throwing).

Objectives	Learning task	Organisation (tips)	Teaching focus (action rules, cues, critical elements or questions)	Timeline
<b>Opening and warming-up</b>				
Active and enjoyable warm-up Fast and accurate ball exchange	<b>Passing ball-tag game</b> Two players passing to one another follow the other pair (running holding hands) if they tag runners, the pairs swap roles.	Organise groups of four with one ball.	Keep eyes up; watch out for others Receiver maintains visual contact with passer; seeks to catch ball while running to approach and tag the runners. Attacker with ball, if close to runners, tag them; if far away, releases ball and continues moving after runners.	9:00-9:05 (5 min.)
<b>Development (learning tasks and game play)</b>				
Split the space and organise several stations with different tasks. Organise groups/teams and introduce a rotation system. Note how the rotation will be implemented. Learners or teams should move from a game play to a more technical task, alternatively.				9:05-9:32 (27 min.)
Spread out attack and keep ball moving toward open spaces	<b>Multiple goals game (3v3)</b>	Organise groups of six with one ball.	Scan the play and seek an open passing line. Pass ball to a free teammate ahead in a suitable manner. Moves away into open spaces, being available to receive ball.	
Throwing technique	<b>Throwing technique and coordination drills</b>	Various tasks with different foot and arm coordination (drills + throwing).	Footwork with raised throwing arm. Contact-impulse with foot contrary to throwing arm.	
Spread out attack and keep ball moving toward open receivers	<b>Possession game (3v3)</b> , being mandatory to go around any cone after passing ball	Square playing area with one cone at each corner.	Ball possessor scans the play and seeks an open passing lane. Supporting ball possessor, by moving into an open path to receive ball.	
Team work to create open scoring opportunities	<b>Game play 4v4 or 3v3</b> , plus goalkeepers, in a small-sized court	Split the space into two or more playing courts	Fair play Works collaboratively either attacking or defending.	
<b>Ending</b>				
Brief review of how to solve numerical advantage situations	Acknowledging: reading the play and seeking the best decision	The learners come together to sit around and in front of the educator.	What to do when getting the ball? What to do without the ball?	

## 14.2 Example of Lesson Form

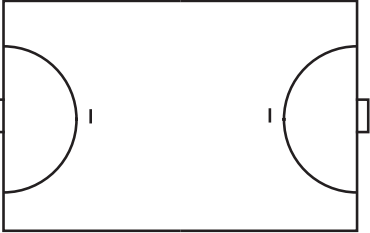
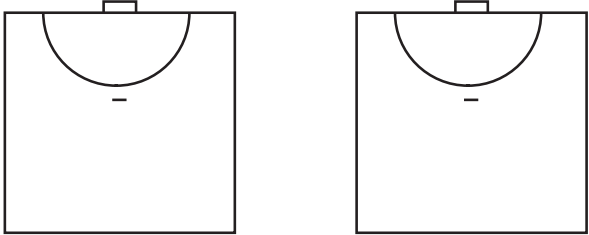
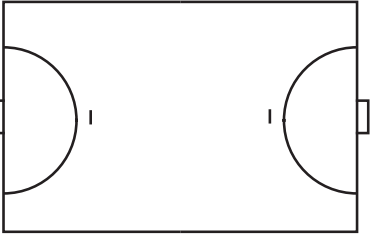
Date:	Time:	N° cycle/lesson:
Place:	Category:	N° of students:
Material:		
Objectives of lesson:		
Duration (intensity)	Contents	Notes
1-5'	Opening the lesson	<i>How to divide group ...</i> <i>Evolution ...</i> <i>Key skills ...</i> <i>Techniques ...</i> <i>Rules ...</i> <i>How to score ...</i>  <i>Main situation/game / exercise/ drill</i>  <i>Major challenge / learning task:</i> <i>- appropriate decision, skill execution, variation of action, etc.</i>  <i>Intensity and duration of specific parts and evolution of activities</i>
5-20' (increasing)		
20-60' (medium)	Main part (development) 	
(high)		
3-15' (medium-low)	Cool-down and ending	<i>Challenging situation, motivation, assessment</i>

---

## Handball courts

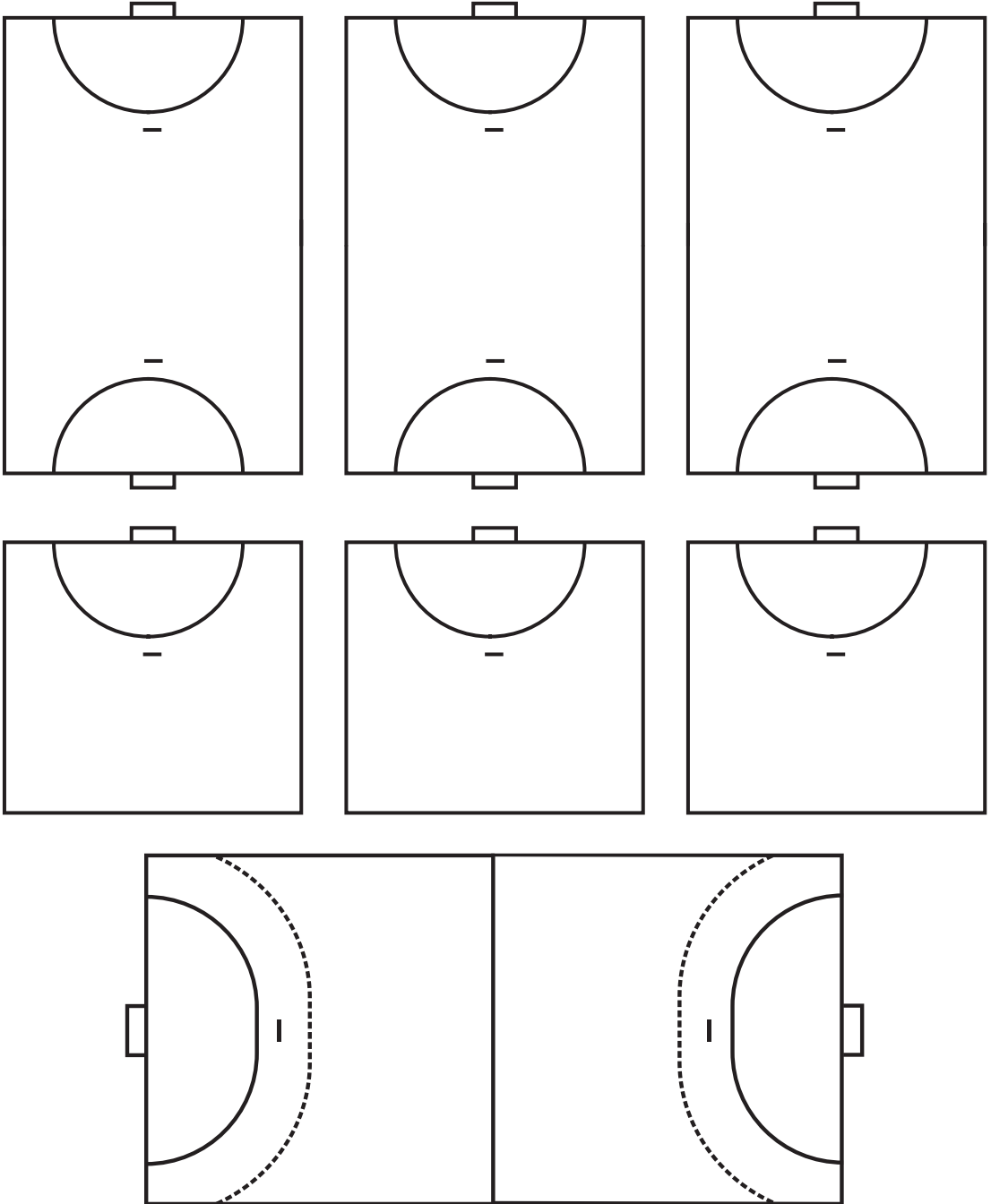

## 14.3 Guide for Events in Schools

### Organisation guide event agenda:

1. Place, date, duration of tournament
2. Team of organisation, staff
3. Number of handball fields
4. Registration forms, information about basic rules of game/ tournament, information about refreshment and prices and all deadlines
5. Number of teams
6. Referees and delegates (PE teachers/ coaches / kids)
7. Number of groups
8. Rules, duration of game, tournament chart
9. Opening and closing ceremonies

### Order of Matches in group:

3 teams		5 teams		6 teams		7 teams				8 teams			
1	2	1	2	1	4	1	4	1	6	2	3	3	6
3	1	3	4	2	5	2	5	2	4	1	5	2	8
2	3	5	1	3	6	3	6	7	3	7	4	5	4
		2	3	5	1	7	1	6	5	6	8	6	1
		5	4	4	2	5	4	1	2	1	2	3	7
		1	3	3	1	2	3	4	7	3	4	4	8
		2	5	6	2	6	7			5	6	2	6
		4	1	5	3	5	1			8	7	3	5
<b>4 teams</b>		3	5	6	4	4	3			4	1	1	7
1	2	4	2	1	2	6	2			5	2	4	6
3	4			3	4	5	7			8	3	8	5
1	3			5	6	3	1			6	7	7	2
2	4			2	3	4	6			4	2	1	3
1	4			1	6	7	2			8	1		
2	3			4	5	3	5			7	5		

### Remarks:

Calculating the number of matches can be made in the following way:

$$\text{n}^\circ \text{ of matches} = \frac{\text{n}^\circ \text{ of teams} \times (\text{n}^\circ \text{ of teams} - 1)}{2}$$

$$\text{n}^\circ \text{ of matches} = \frac{5 \times (5 - 1)}{2} = 10$$

**Table of results (e.g., group of 5 teams):**

DATE:		NAME of event / group:								
Name of teams	N°	1	2	3	4	5	Total score	Goal difference	Points	Rank
	1									
	2									
	3									
	4									
	5									

**Dividing of handball court:**

Example 1

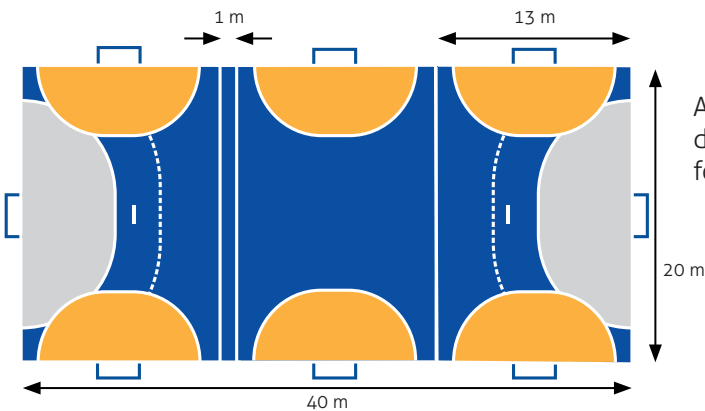

An official handball court can be divided into three smaller courts for mini handball events.

Example 2

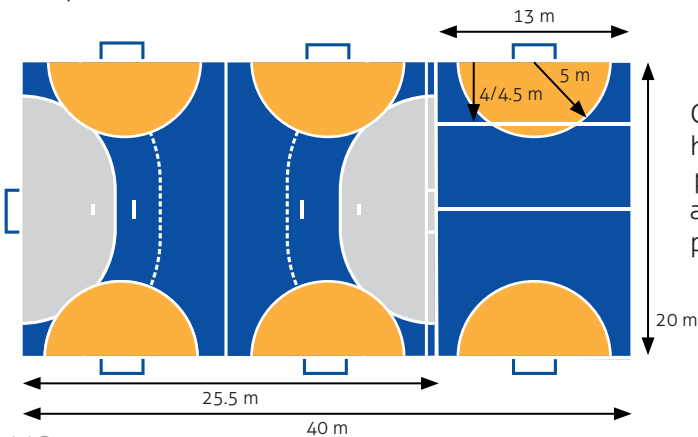

Creating a field on two thirds of a handball court (about 25.5 m x 20 m) provides enough space to play 6v6, and as the court shorter, positional play will occur more often.









# FUN, PASSION AND HEALTH

PLAY AND ENJOY HANDBALL

