

ΙΑΤΡΙΚΗ ΦΥΣΙΚΗ

Π. Παπαγιάννης & Ε. Στυλιάρης
ΠΑΝΕΠΙΣΤΗΜΙΟΝ ΑΘΗΝΩΝ
2019 - 2020

Magnetic Resonance Imaging (MRI)

- Απεικόνιση Μαγνητικού Συντονισμού
- Μετάπτωση Larmor
- Χαρακτηριστικοί Χρόνοι T_1 και T_2
- Μαγνητική Απεικόνιση

ΑΠΕΙΚΟΝΙΣΗ ΜΑΓΝΗΤΙΚΟΥ ΣΥΝΤΟΝΙΣΜΟΥ

Magnetic Resonance Imaging (MRI)

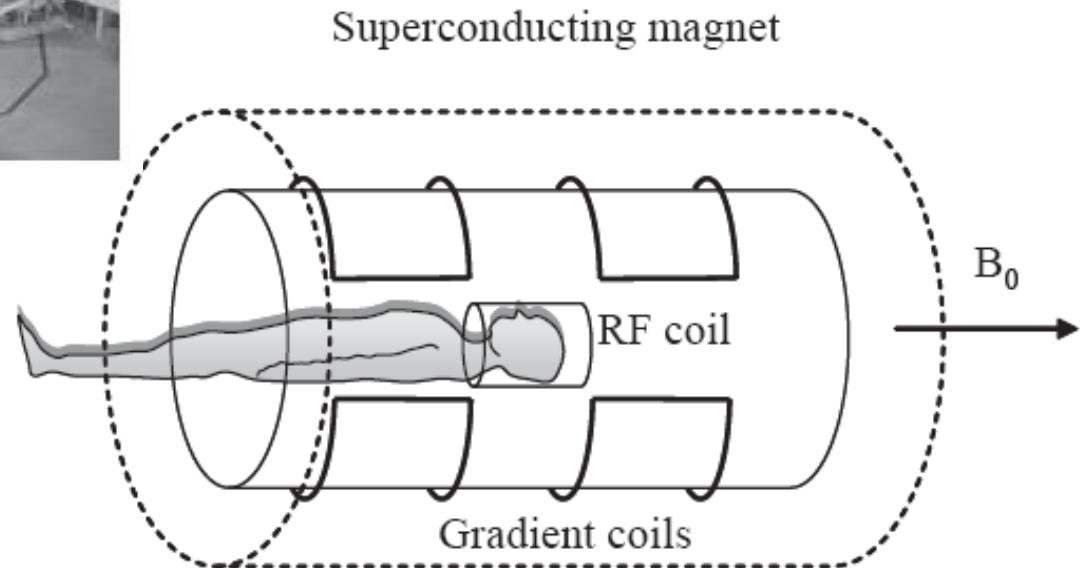
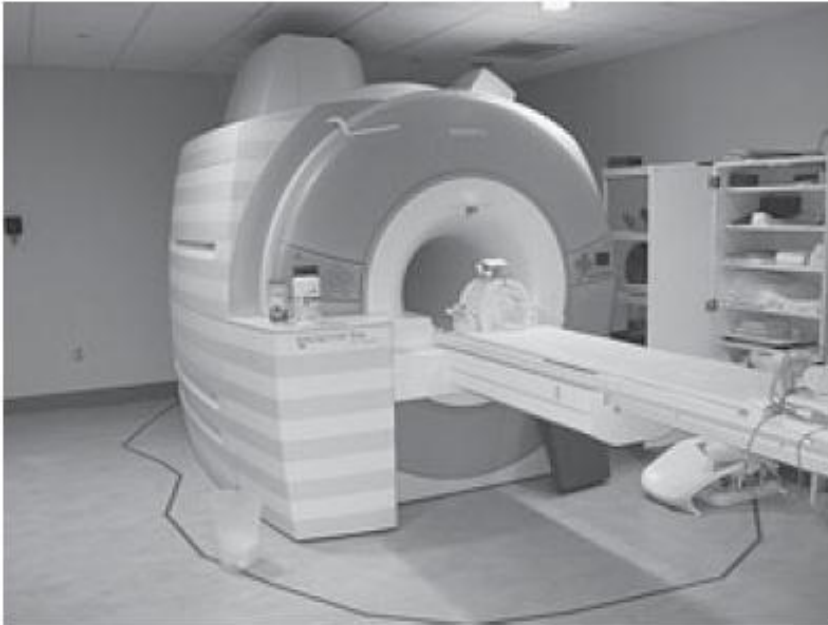

ΑΠΕΙΚΟΝΙΣΗ ΜΑΓΝΗΤΙΚΟΥ ΣΥΝΤΟΝΙΣΜΟΥ

$$\text{Συχνότητα Larmor: } \omega = \gamma B_0$$

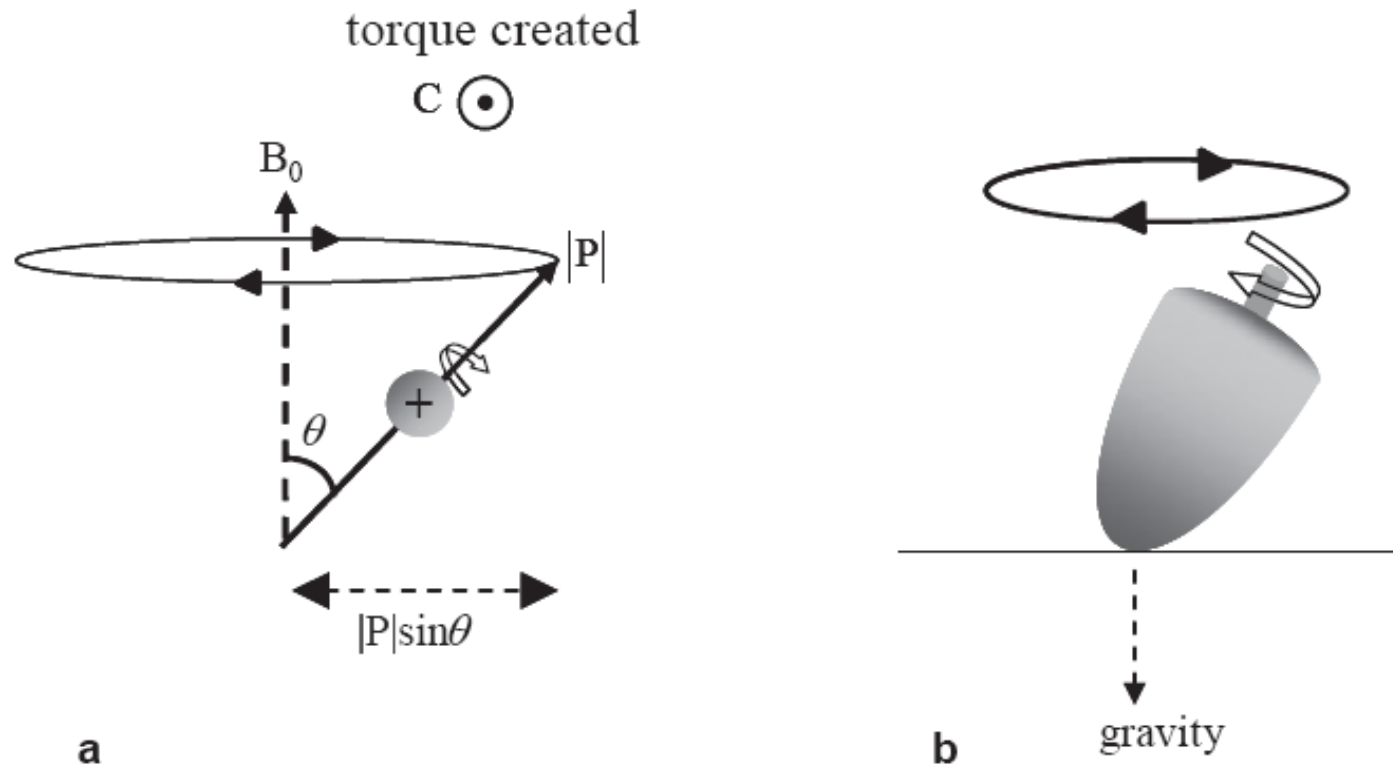

A proton in a magnetic field. (a) Using classical mechanics, the torque C acting on the magnetic moment, spinning about an internal axis, causes it to precess about the vertical axis, B_0 . (b) A familiar analogy is that of a spinning top: in this case the vertical force is gravity.

ΑΠΕΙΚΟΝΙΣΗ ΜΑΓΝΗΤΙΚΟΥ ΣΥΝΤΟΝΙΣΜΟΥ

$$V_{\text{mag}} = -\vec{\mu} \cdot \vec{B}$$

$$\vec{\mu} = g_p \mu_p \cdot \frac{\vec{J}}{\hbar} = \gamma \cdot \vec{J}$$

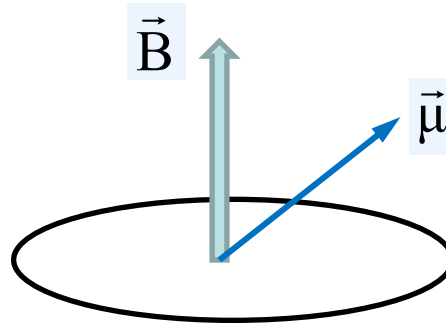

$$\omega = \gamma \cdot B$$

$$\vec{\tau} = \vec{\mu} \times \vec{B}$$

$$\gamma_{\omega} = 267.5 \frac{\text{MHz}}{\text{T}}$$

$$\gamma_f = 42.5 \frac{\text{MHz}}{\text{T}}$$

Μετάπτωση πρωτονίου με συχνότητα ω (συχνότητα Larmor)

ΑΠΕΙΚΟΝΙΣΗ ΜΑΓΝΗΤΙΚΟΥ ΣΥΝΤΟΝΙΣΜΟΥ

$$\vec{\mu} = g_p \mu_p \cdot \frac{\vec{J}}{\hbar} = \gamma \cdot \vec{J}$$

$$g_p = 5.5858$$

$$\hbar = 6.58 \times 10^{-22} \text{ MeV} \cdot \text{s}$$

$$\mu_p = \frac{e \hbar}{2m_p c} = 3.152 \text{ MeV/T}$$

$$\gamma_\omega = \frac{g_p \cdot \mu_p}{\hbar} = 5.5858 \times \frac{3.152 \times 10^{-14} \text{ MeV/T}}{6.58 \times 10^{-22} \text{ MeV} \cdot \text{s}} = 267.5 \frac{\text{MHz}}{\text{T}}$$

Μετάπτωση πρωτονίου με συχνότητα ω (συχνότητα Larmor)

ΑΠΕΙΚΟΝΙΣΗ ΜΑΓΝΗΤΙΚΟΥ ΣΥΝΤΟΝΙΣΜΟΥ

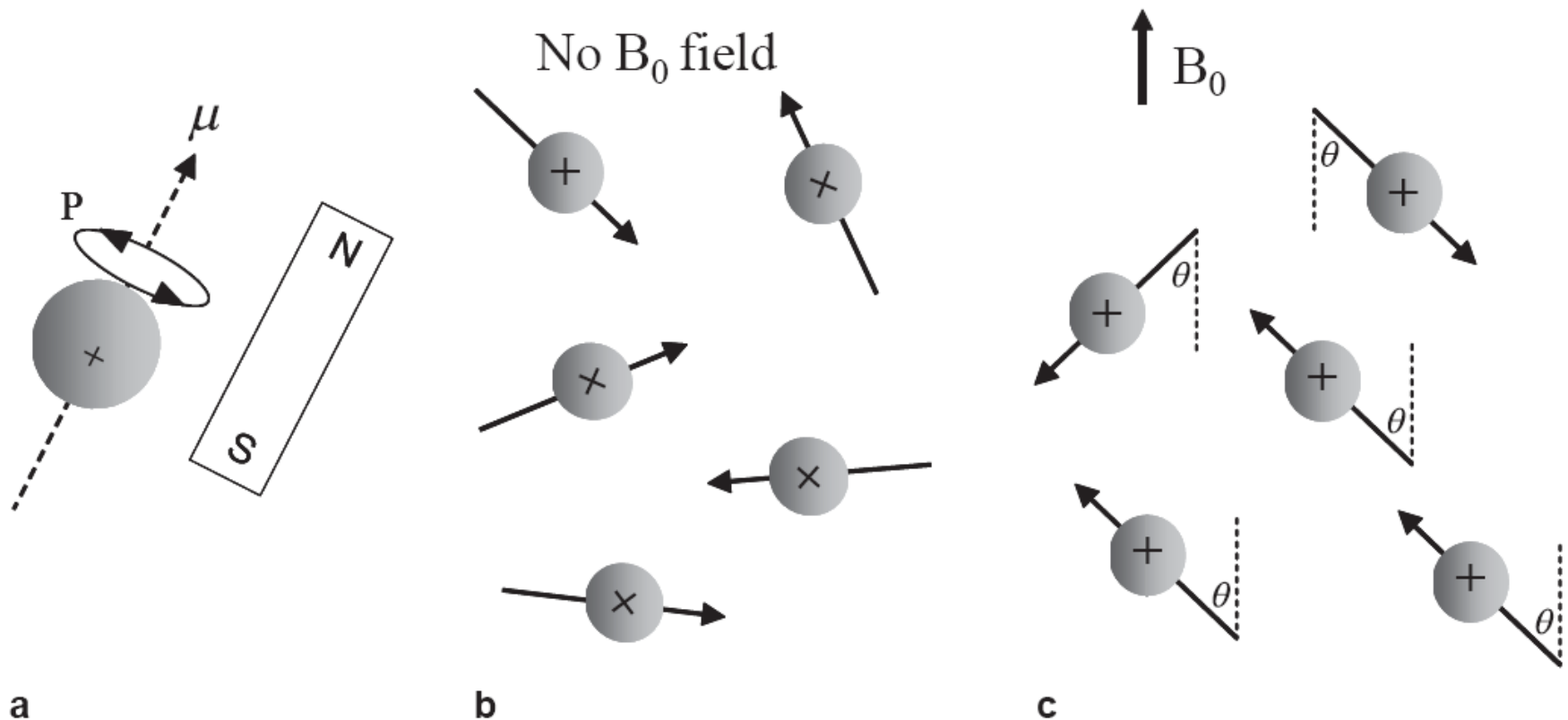

(a) The internal rotation of a proton creates a magnetic moment, and so the proton acts as a magnet with north and south pole. (b) In the absence of a strong magnetic field, the orientations of the magnetic moments are completely random. (c) When there is a strong magnetic field present the magnetic moments must align at an angle $\theta = \pm 54.7^\circ$ with respect to the direction of B_0 .

ΑΠΕΙΚΟΝΙΣΗ ΜΑΓΝΗΤΙΚΟΥ ΣΥΝΤΟΝΙΣΜΟΥ

Magnetic Resonance Imaging (MRI)

$$\Delta E = \frac{\gamma \hbar B_0}{2\pi}, \quad \frac{N_{\text{anti-parallel}}}{N_{\text{parallel}}} = \exp - \left[\frac{\Delta E}{kT} \right] = \exp - \left[\frac{\gamma \hbar B_0}{2\pi kT} \right].$$

$$\frac{N_{\text{anti-parallel}}}{N_{\text{parallel}}} = 1 - \left[\frac{\gamma \hbar B_0}{2\pi kT} \right]$$

$$N_{\text{parallel}} - N_{\text{anti-parallel}} = N_{\text{total}} \frac{\gamma \hbar B_0}{4\pi kT}$$

ΑΠΕΙΚΟΝΙΣΗ ΜΑΓΝΗΤΙΚΟΥ ΣΥΝΤΟΝΙΣΜΟΥ

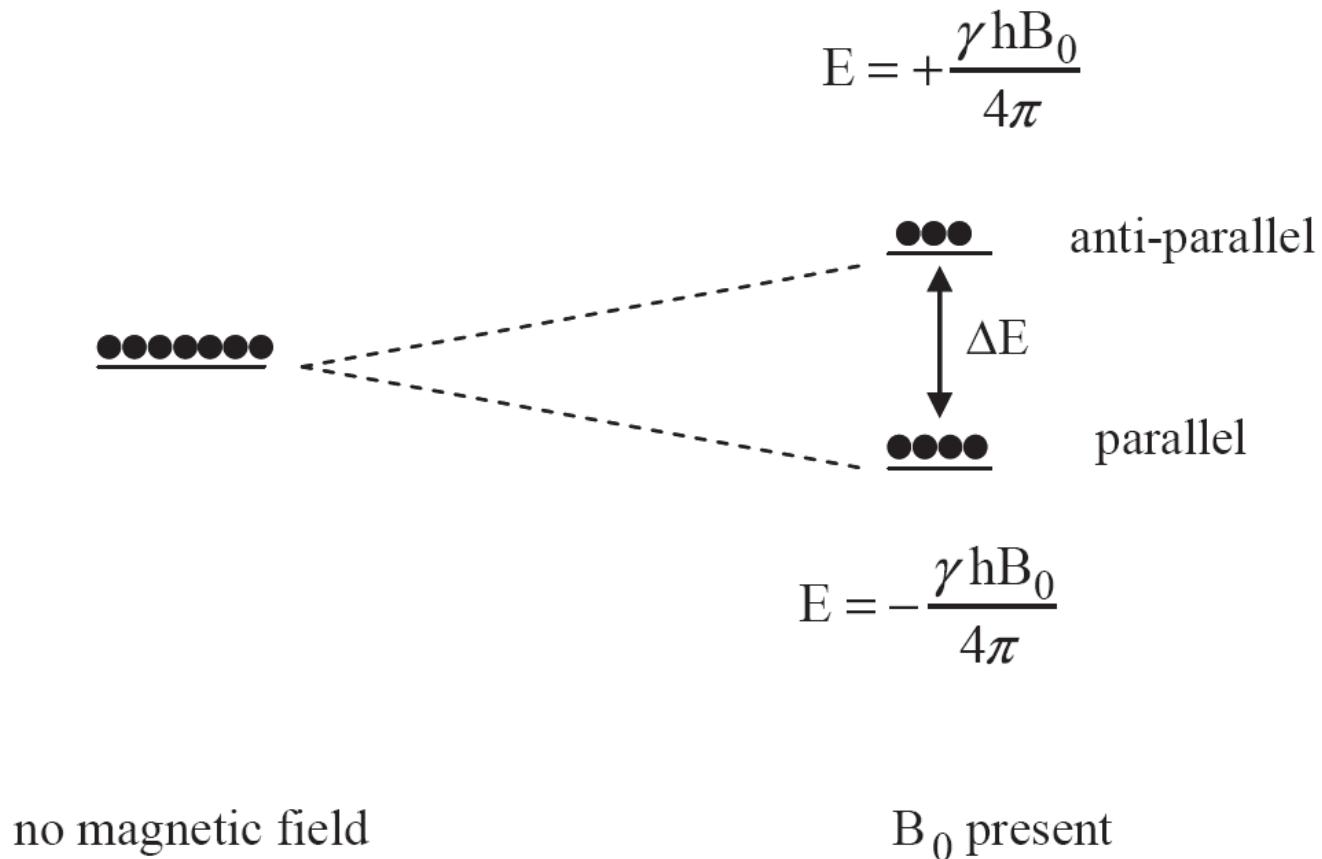

$$N_{\text{parallel}} - N_{\text{anti-parallel}} = N_{\text{total}} \frac{\gamma \hbar B_0}{4\pi kT}$$

ΑΠΕΙΚΟΝΙΣΗ ΜΑΓΝΗΤΙΚΟΥ ΣΥΝΤΟΝΙΣΜΟΥ

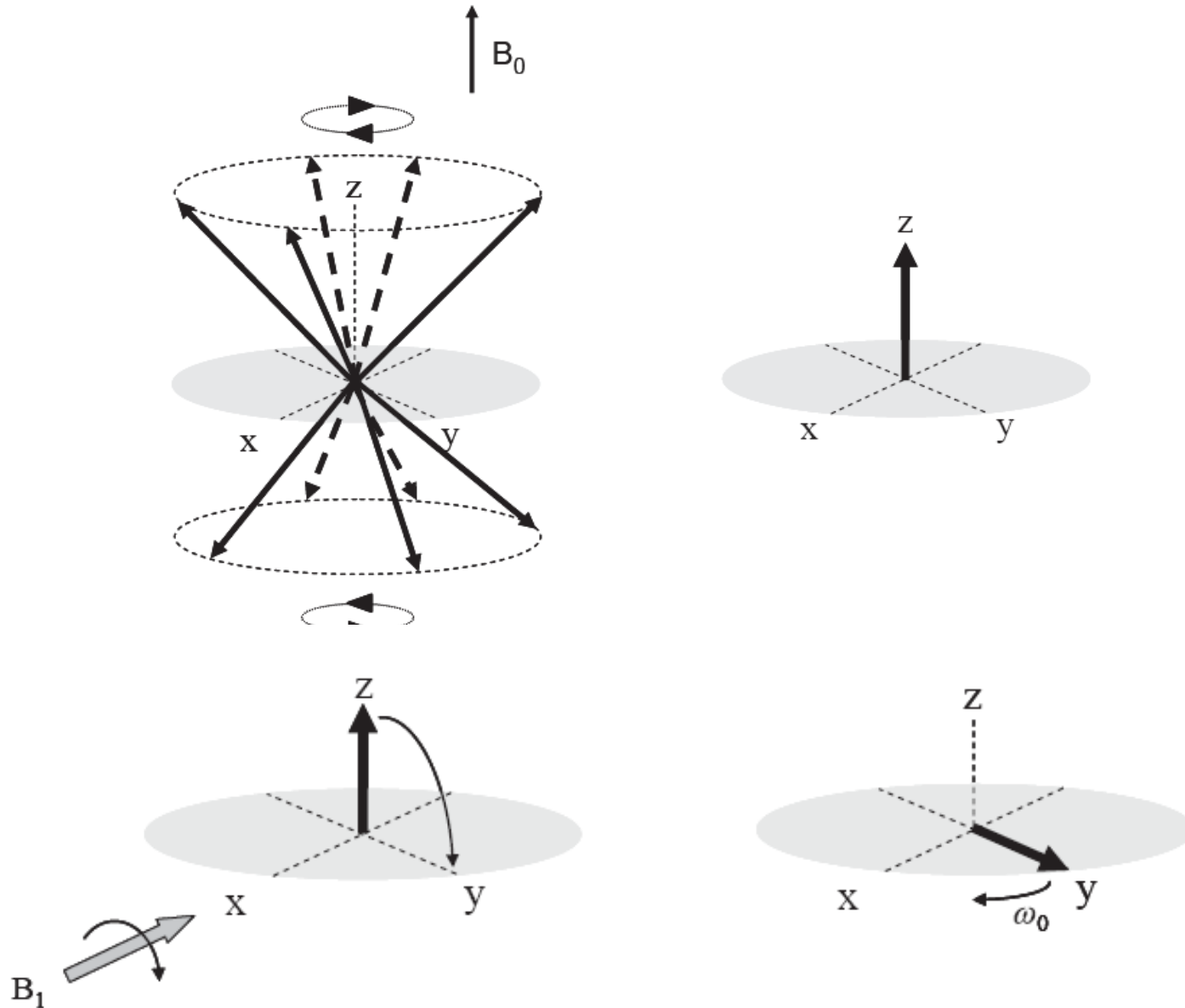

ΑΠΕΙΚΟΝΙΣΗ ΜΑΓΝΗΤΙΚΟΥ ΣΥΝΤΟΝΙΣΜΟΥ

Επαγωγική Δράση (Νόμος Faraday)

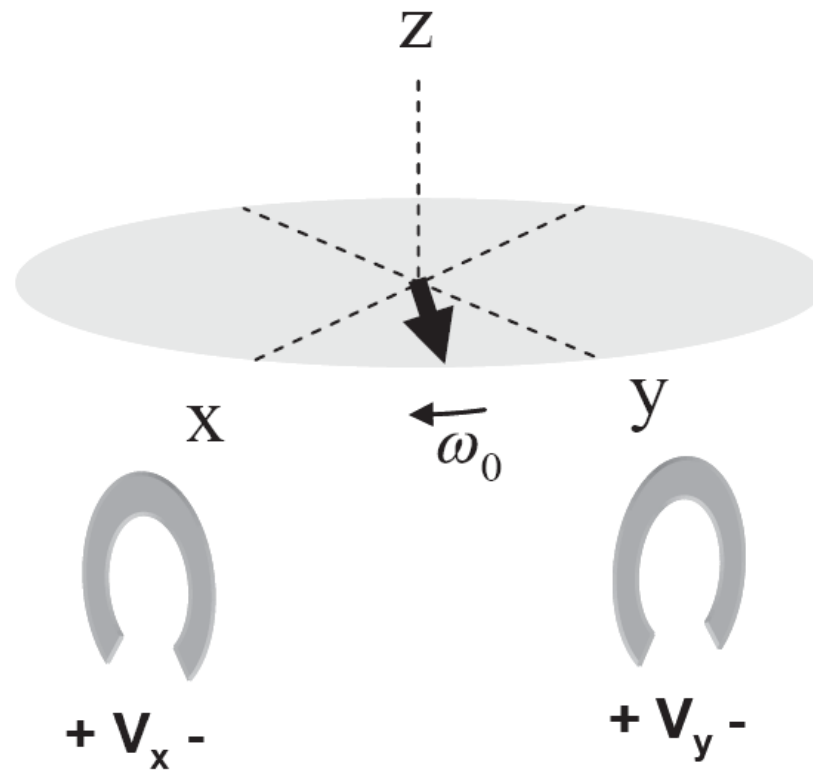

ΑΠΕΙΚΟΝΙΣΗ ΜΑΓΝΗΤΙΚΟΥ ΣΥΝΤΟΝΙΣΜΟΥ

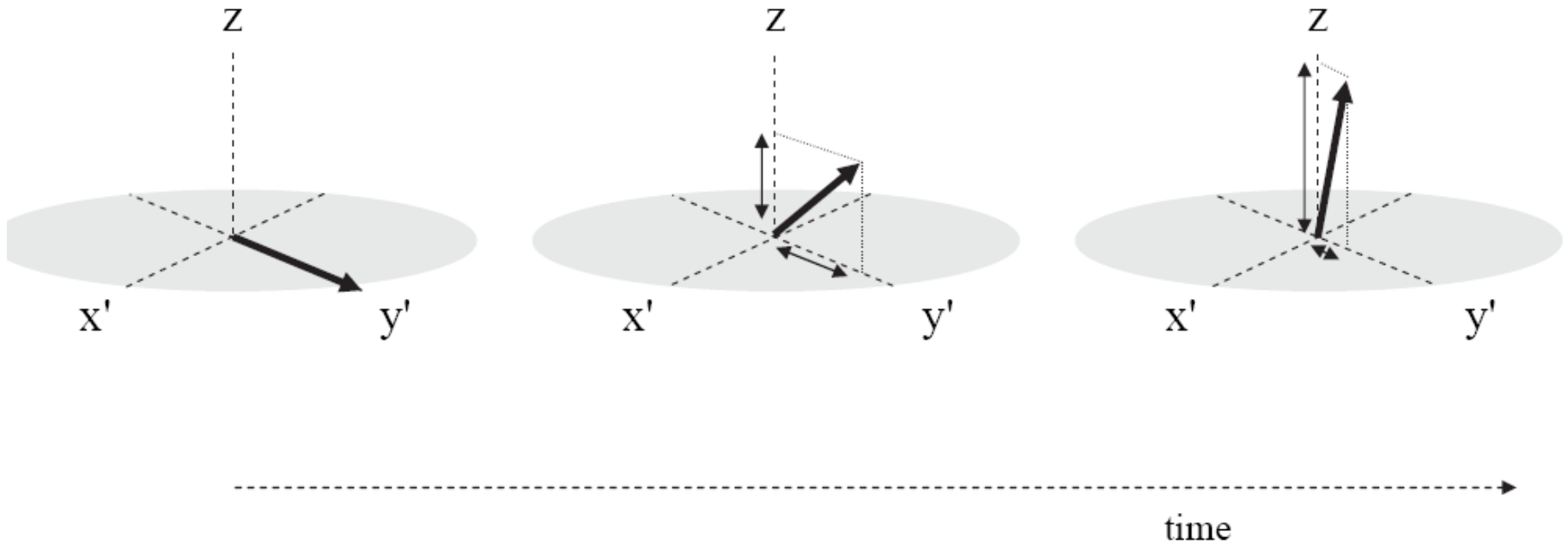

$$M_Z(t) = M_0 \left(1 - e^{-\frac{t}{T_1}} \right)$$

$$M_y(t) = M_0 \sin \alpha \exp - \left(\frac{t}{T_2} \right)$$

ΑΠΕΙΚΟΝΙΣΗ ΜΑΓΝΗΤΙΚΟΥ ΣΥΝΤΟΝΙΣΜΟΥ

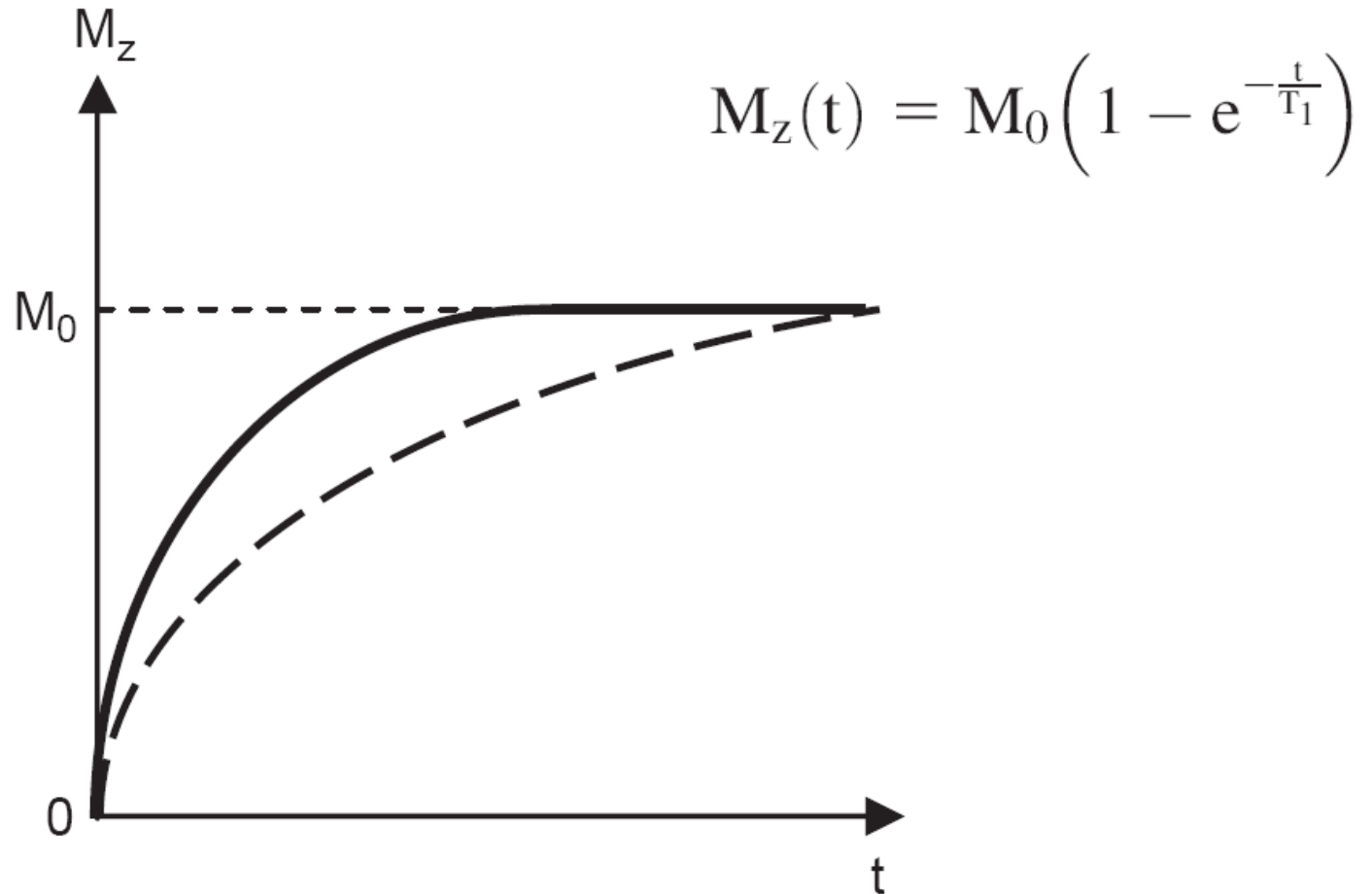

The recovery of M_z magnetization as a function of time after a 90 pulse for a tissue with short T_1 relaxation time (solid line) and long T_1 relaxation time (dashed line).

ΑΠΕΙΚΟΝΙΣΗ ΜΑΓΝΗΤΙΚΟΥ ΣΥΝΤΟΝΙΣΜΟΥ

$$M_y(t) = M_0 \sin \alpha \exp - \left(\frac{t}{T_2} \right)$$

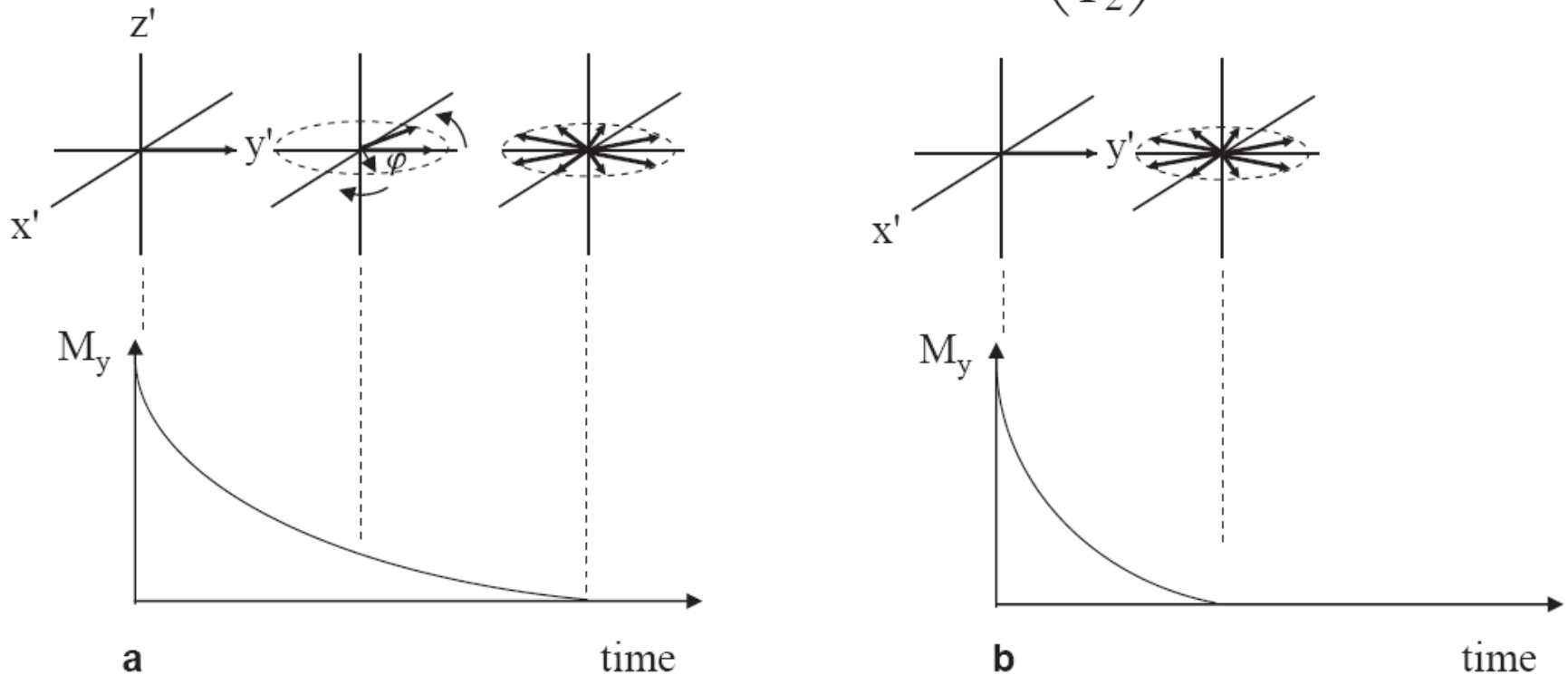

The time-dependence of the M_y component of magnetization for (a) a tissue with relatively long T_2^* and (b) one with a shorter T_2^* . The decrease in signal occurs due to the loss of phase coherence of the protons, i.e. protons precess at slightly different frequencies, thus acquiring different phases and reducing the net magnetization along the y -axis. The faster the dephasing process the shorter the T_2^* relaxation time.

ΑΠΕΙΚΟΝΙΣΗ ΜΑΓΝΗΤΙΚΟΥ ΣΥΝΤΟΝΙΣΜΟΥ

MRI – Χαρακτηριστικοί χρόνοι αποκατάστασης T1 και T2

Table 5.1: Tissue relaxation times (ms) at 1.5 and 3 Tesla

Tissue	T ₁ (1.5 T)	T ₁ (3 T)	T ₂ (1.5 T)	T ₂ (3 T)
Brain (white matter)	790	1100	90	60
Brain (grey matter)	920	1600	100	80
Liver	500	800	50	40
Skeletal muscle	870	1420	60	30
Lipid (subcutaneous)	290	360	160	130
Cartilage	1060	1240	42	37

ΑΠΕΙΚΟΝΙΣΗ ΜΑΓΝΗΤΙΚΟΥ ΣΥΝΤΟΝΙΣΜΟΥ

MRI - Spin Echo Technique

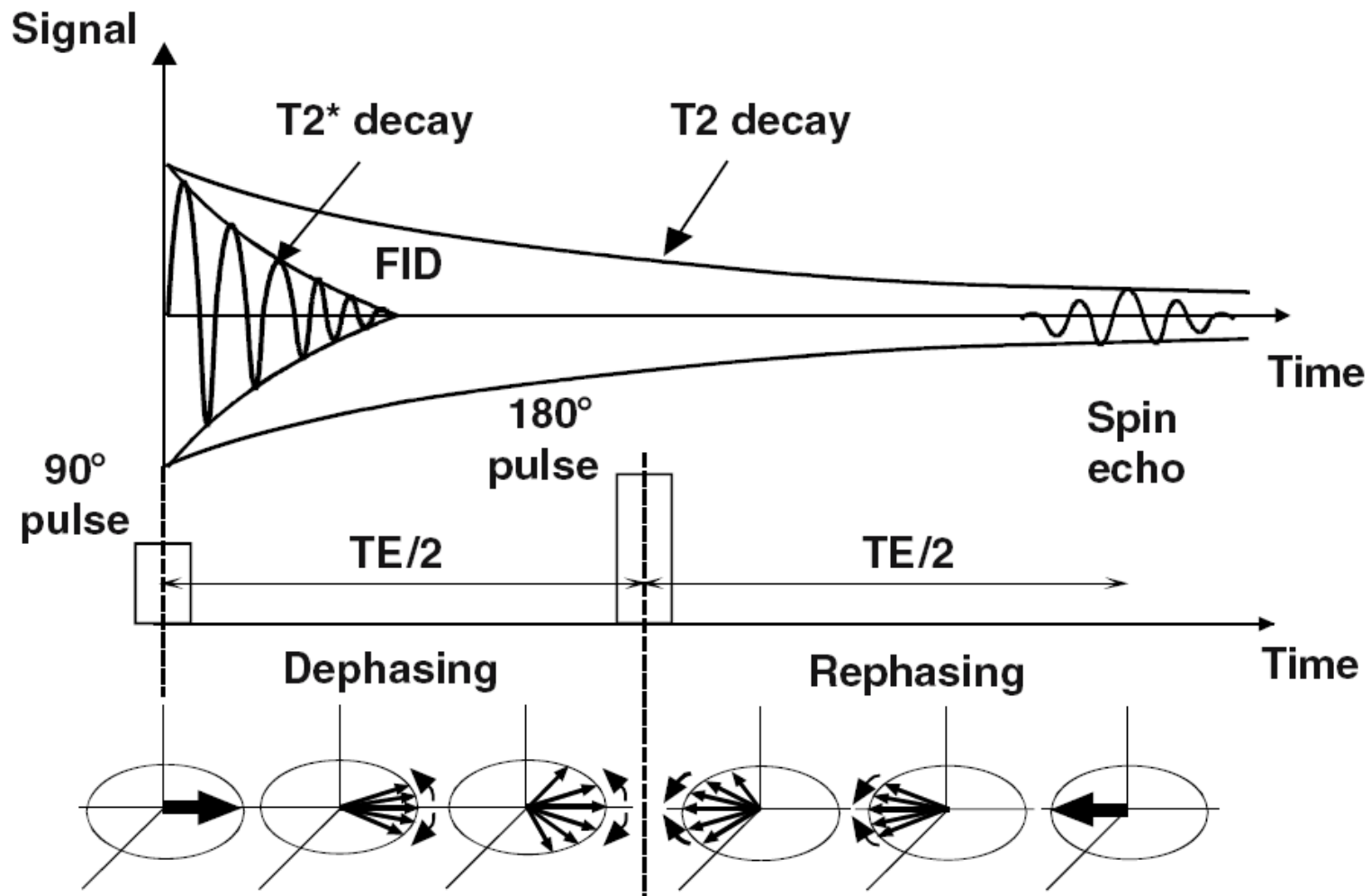

ΑΠΕΙΚΟΝΙΣΗ ΜΑΓΝΗΤΙΚΟΥ ΣΥΝΤΟΝΙΣΜΟΥ

Coronal slice

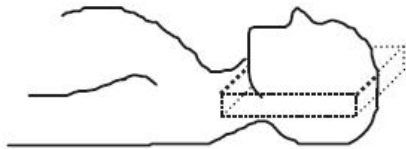

G_y

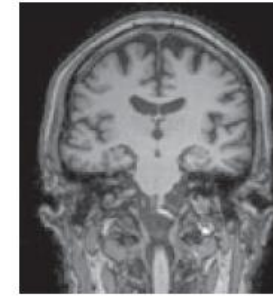

Axial slice

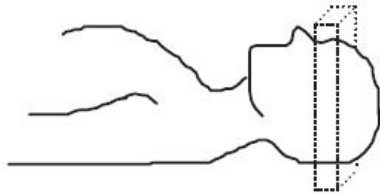

G_z

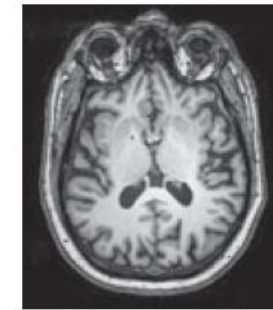

Sagittal slice

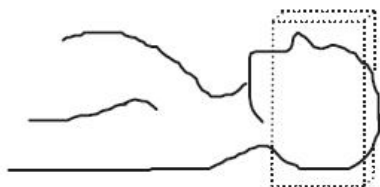

G_x

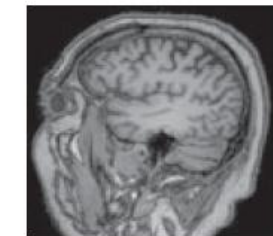

ΑΠΕΙΚΟΝΙΣΗ ΜΑΓΝΗΤΙΚΟΥ ΣΥΝΤΟΝΙΣΜΟΥ

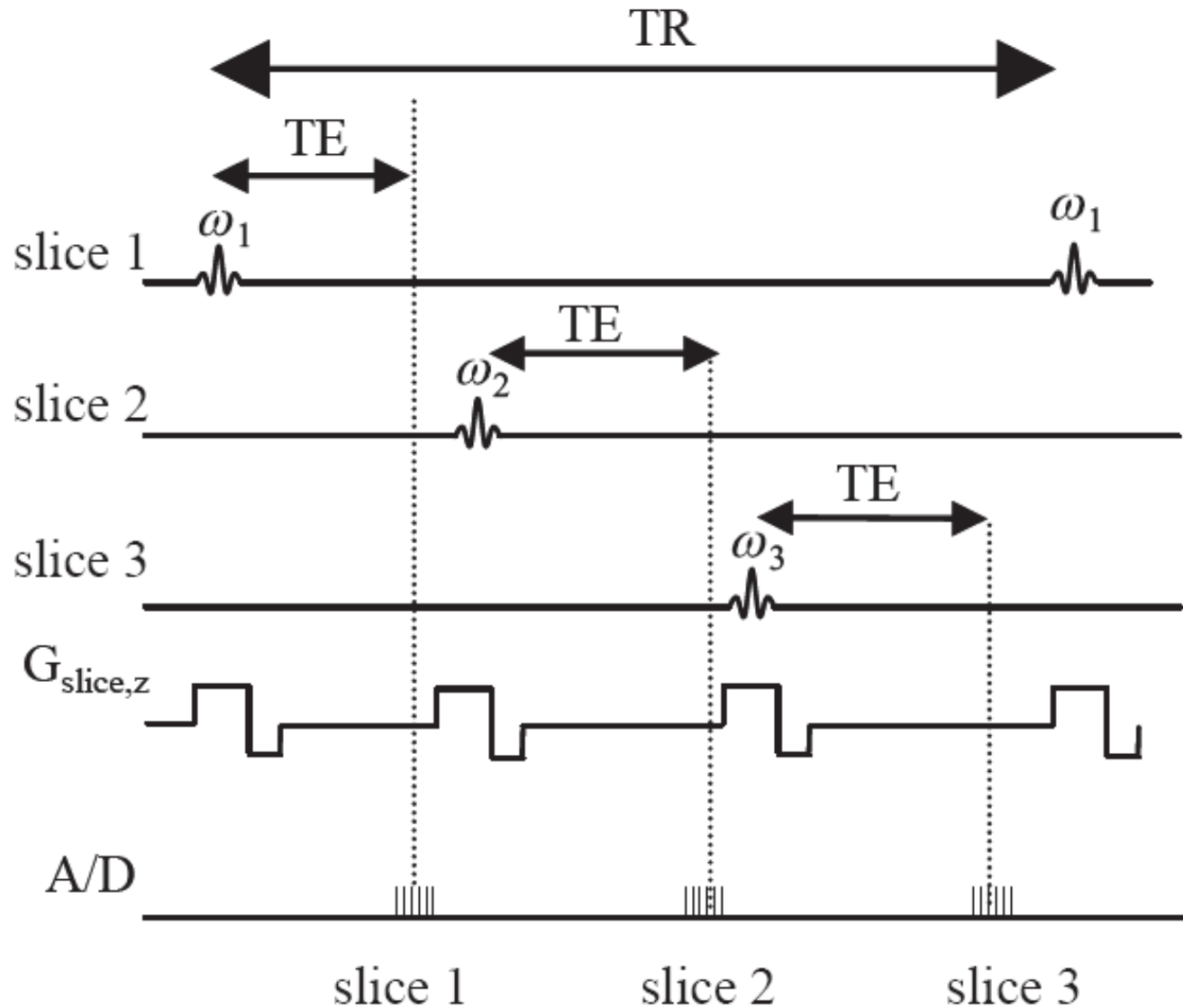

ΑΠΕΙΚΟΝΙΣΗ ΜΑΓΝΗΤΙΚΟΥ ΣΥΝΤΟΝΙΣΜΟΥ



slice 1

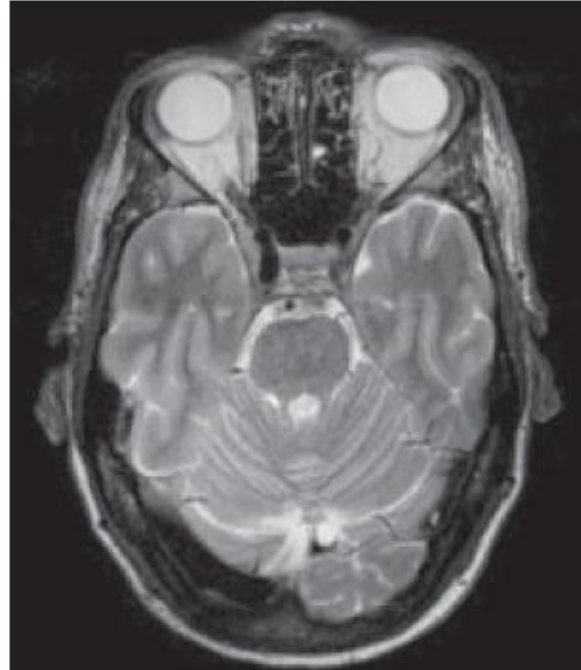

slice 2

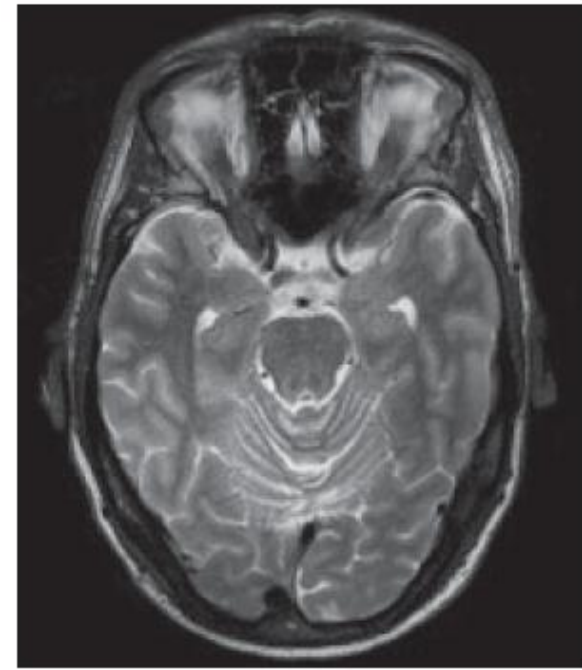

slice 3